









































# 纜扣系列

 ZG-003	 ZG-5100/6	 ZG-5100/7	 ZG-5100/15	 ZG-003A
 ZG-0710	 ZG-0707	 ZG-002	 ZG-301	 ZG-303
 ZG-066.5	 ZG-0608	 ZG-067.5	 ZG-0606	 ZG-0610
 ZG-302	 ZG-304	 ZG-305	 ZG-306	 307
 ZG-201	 ZG-202	 305A	 ZG-006	 ZG-007
 ZG-033	 ZG-308	 ZG-005	 ZG-004	 ZG-004B
 ZG-250	 ZG-251	 ZG-351	 008	 009
 092	 NB-032	 NB-035	 039	 039-1
 SWC-206	 094	 OCC-5	 008A	 ZG-86

003  
5100/6 歐規外牙線扣 (全牙)  
STRAIN RELIEF

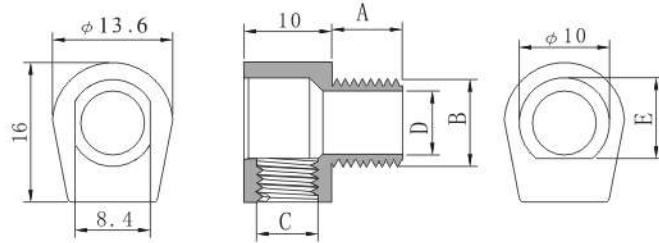

型號 ITEM NO	材質 MATERIAL	尺寸 (DIMENSIONS)					包裝 PACKING	備注 REMARK
		A	B	C	D	E		
ZG-003	NYLON66/PC	8.0	M10	M7	φ7.2	9.0	2000PCS	
ZG-5100/6	NYLON66/PC	10	M10	M7	φ7.2	9.0	2000PCS	
ZG-003J	NYLON66/PC	5	M10	M7	φ7.5	9.0	2000PCS	

5100/7 歐規外牙線扣 (全牙)  
STRAIN RELIEF

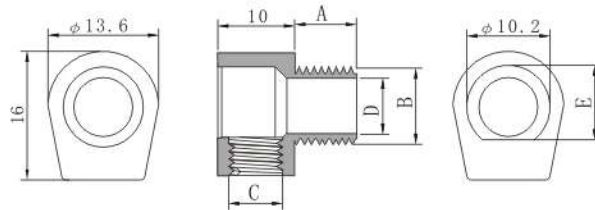

型號 ITEM NO	材質 MATERIAL	尺寸 (DIMENSIONS)					包裝 PACKING	備注 REMARK
		A	B	C	D	E		
ZG-5100/7	NYLON66/PC	8.0	M10	M7	φ7.2	9.0	2000PCS	
ZG-5100/6A	PA66	10	M10	M7	φ7.5	9.0	2000PCS	

5100/15  
5100/E 歐規外牙線扣 (全牙)  
STRAIN RELIEF

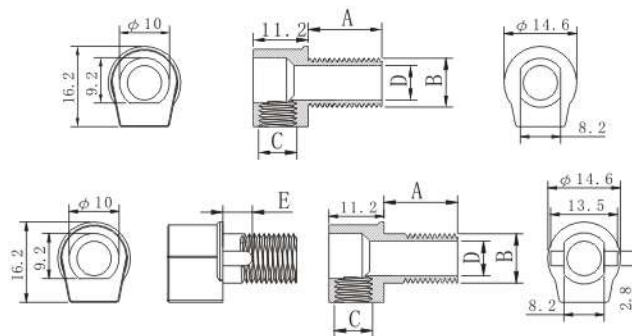

型號 ITEM NO	材質 MATERIAL	尺寸 (DIMENSIONS)					包裝 PACKING	備注 REMARK
		A	B	C	D	E		
ZG-5100/15	NYLON66/PC	15	M10	M7	φ7.5		2000PCS	
ZG-5100/E	NYLON66/PC	15	M10	M7	φ7.5	6.0	2000PCS	有卡位

### 003A 003B 歐規線扣

STRAIN RELIEF

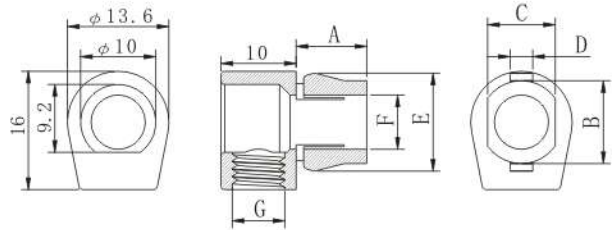

型號 ITEM NO	材質 MATERIAL	尺寸 (DIMENSIONS)							包裝 PACKING	備註 REMARK
		A	B	C	D	E	F	G		
ZG-003A	NYLON66/PC	9.2	∅11	9.0	3.0	13	∅7.2	M7	2000PCS	
ZG-003B	NYLON66/PC	4.8	∅10	8.4	3.3	11.8	∅7.2	M7	2000PCS	

### M7 塑膠螺絲

PLASTIC SCREW

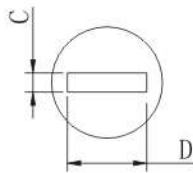
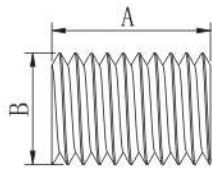

型號 ITEM NO	材質 MATERIAL	尺寸 (DIMENSIONS)				包裝 PACKING
		A 長度	B	C	D	
ZG-0710	PC	10	M7	1.7	5.0	2000PCS
ZG-0712	PC	12	M7	1.7	5.0	2000PCS
ZG-0707	PC	7	M7	1.3	5.0	2000PCS

### 002 扣式線扣

STRAIN RELIEF

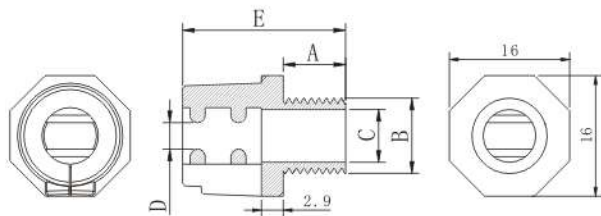

型號 ITEM NO	材質 MATERIAL	尺寸 (DIMENSIONS)					包裝 PACKING	備註 REMARK
		A	B	C	D	E		
ZG-002	NYLON66	8.0	M10	∅7.0	3.5	21.5	2000PCS	

### 301 303 歐規內牙線扣

STRAIN RELIEF

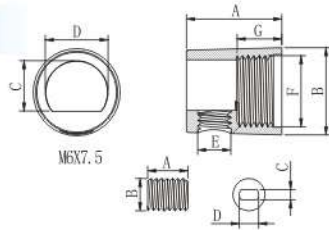

型號 ITEM NO	材質 MATERIAL	尺寸 (DIMENSIONS)							包裝 PACKING	備註 REMARK
		A	B	C	D	E	F	G		
ZG-301	NYLON66/PC	16.5	∅12.5	6.2	∅8	M6	M10	6.8	2000PCS	
ZG-303A	NYLON66/PC	17	∅15.4	7.5	∅11.2	M6	M12	8.0	2000PCS	
ZG-303	NYLON66/PC	16.9	∅15.4	7.5	∅11.2	M6	4分18牙	8.0	2000PCS	
ZG-0606	PC	6	M6	1.5	3.5				2000PCS	
ZG-0608	PC	8	M6	1.5	3.5				2000PCS	

### M6 塑膠螺絲

PLASTIC SCREW



錐度螺絲 M6X6.5

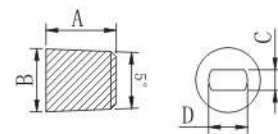

全牙螺絲 M6X6 M6X7.5 M6X10

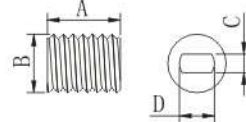

型號 ITEM NO	材質 MATERIAL	尺寸 (DIMENSIONS)				包裝 PACKING	備註 REMARK
		A	B	C	D		
ZG-0606	PC	6	M6	1.5	3.5	2000PCS	全牙螺絲
ZG-067.5	PC	7.5	M6	1.5	3.5	2000PCS	全牙螺絲
ZG-066.5	PC	6.5	M6	2.0	3.5	2000PCS	錐度螺絲
ZG-0610	PC	10	M6	1.5	3.5	2000PCS	全牙螺絲
ZG-0608	PC	8	M6	1.2	3.8	2000PCS	全牙螺絲
ZG-0408	PC	8	M4	1.2	2	2000PCS	全牙螺絲
ZG-0508	PC	8	M5	1.2	2	2000PCS	全牙螺絲
SW-0405	PC	5	M4	1.5	2.5	5000PCS	全牙螺絲
SW-0604	PP	4	M6	1.5	3.5	5000PCS	全牙螺絲
ZG-0405	PC	5	M4	1.5	2	5000PCS	全牙螺絲

### 302 歐規外牙線扣

STRAIN RELIEF

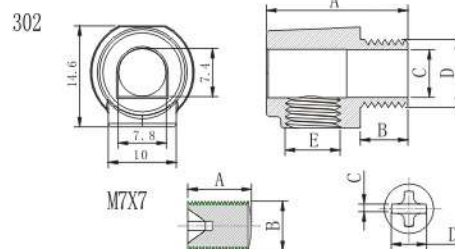

型號 ITEM NO	材質 MATERIAL	尺寸 (DIMENSIONS)					包裝 PACKING	備註 REMARK
		A	B	C	D	E		
ZG-302	NYLON66	21	7.1	∅7.0	M10	M7	1000PCS	
ZG-0707	PC	7.0	M7	1.1	5.0		1000PCS	

301 303 歐規內牙線扣  
STRAIN RELIEF

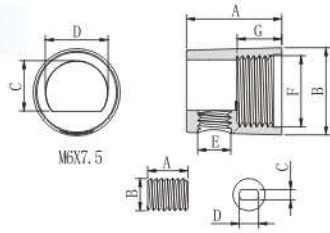

型號 ITEM NO	材質 MATERIAL	尺寸 (DIMENSIONS)							包裝 PACKING	備註 REMARK
		A	B	C	D	E	F	G		
ZG-301	NYLON66/PC	16.5	∅12.5	6.2	∅8	M6	M10	6.8	2000PCS	
ZG-303A	NYLON66/PC	17	∅15.4	7.5	∅11.2	M6	M12	8.0	2000PCS	
ZG-303	NYLON66/PC	16.9	∅15.4	9.0	∅11.2	M6	4分18牙	8.0	2000PCS	
ZG-0606	PC	6	M6	1.5	3.5				2000PCS	
ZG-0608	PC	8	M6	1.5	3.5				2000PCS	

M6 M7 塑膠螺絲  
PLASTIC SCREW



錐度螺絲 M6X6.5

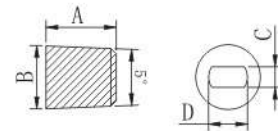

全牙螺絲 M6X6 M6X7.5 M6X10

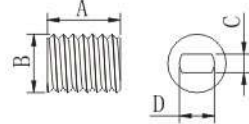

型號 ITEM NO	材質 MATERIAL	尺寸 (DIMENSIONS)				包裝 PACKING	備註 REMARK
		A	B	C	D		
ZG-0606	PC	6	M6	1.5	3.5	2000PCS	全牙螺絲
ZG-067.5	PC	7.5	M6	1.5	3.5	2000PCS	全牙螺絲
ZG-066.5	PC	6.5	M6	2.0	3.5	2000PCS	錐度螺絲
ZG-0610	PC	10	M6	1.5	3.5	2000PCS	全牙螺絲
ZG-0608	PC	8	M6	1.2	3.8	2000PCS	全牙螺絲
ZG-0408	PC	8	M4	1.2	2	2000PCS	全牙螺絲
ZG-0508	PC	8	M5	1.2	2	2000PCS	全牙螺絲
SW-0405	PC	5	M4	1.5	2.5	5000PCS	全牙螺絲
SW-0604	PP	4	M6	1.5	3.5	5000PCS	全牙螺絲
ZG-0405	PC	5	M4	1.5	2	5000PCS	全牙螺絲
ZG-0710	PC	10	M7	1.7	5.0	2000PCS	全牙螺絲
ZG-0712	PC	12	M7	1.7	5.0	2000PCS	全牙螺絲
ZG-0707	PC	7	M7	1.3	5.0	2000PCS	全牙螺絲

302 歐規外牙線扣  
STRAIN RELIEF

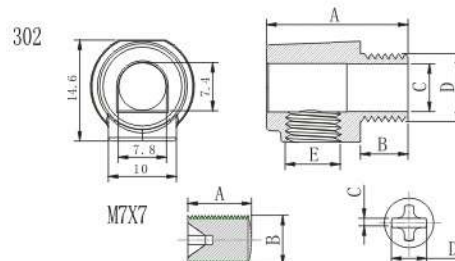

型號 ITEM NO	材質 MATERIAL	尺寸 (DIMENSIONS)					包裝 PACKING	備註 REMARK
		A	B	C	D	E		
ZG-302	NYLON66	21	7.1	∅7.0	M10	M7	1000PCS	
ZG-0707	PC	7.0	M7	1.1	5.0		1000PCS	

### 304 305 歐規外牙線扣

STRAIN RELIEF

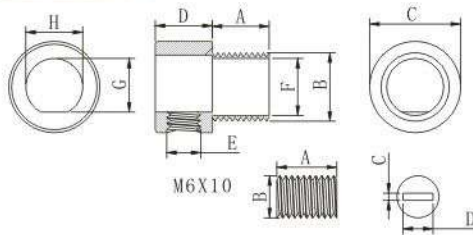

型號 ITEM NO	材質 MATERIAL	尺寸 (DIMENSIONS)								包裝 PACKING	備注 REMARK
		A	B	C	D	E	F	G	H		
ZG-304	NYLON66	10.2	M12	φ16	10	M6	φ10	10	φ11.2	2000PCS	
ZG-305	NYLON66	6.5	M10	φ13	12.2	M6	φ7	6.6	φ7.2	2000PCS	
ZG-0610	NYLON66/PC	10	M6	1.5	3.5					2000PCS	
ZG-318	NYLON66	18	M10	φ13	17	M6	φ7	5	7	1000PCS	
ZG-0606	PC	6	M6	1.9	3.6					2000PCS	

### 306 線扣型燈頭

STRAIN RELIEF

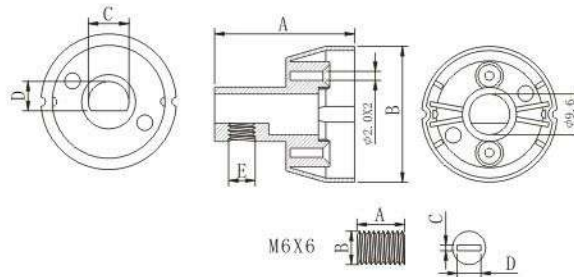

型號 ITEM NO	材質 MATERIAL	尺寸 (DIMENSIONS)					包裝 PACKING	備注 REMARK
		A	B	C	D	E		
ZG-306	NYLON66/PC	31.5	φ30	φ9	6.5	M6	2000PCS	
ZG-0606	PC	6	M6	1.5	3.5		2000PCS	

### 307 吊燈線扣

PENDANT STRAIN RELIEF

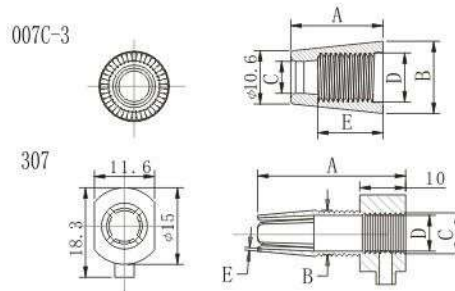

型號 ITEM NO	材質 MATERIAL	尺寸 (DIMENSIONS)					包裝 PACKING	螺絲 SCREW
		A	B	C	D	E		
ZG-007C-3	NYLON66/PC	19	φ14.8	φ7.5	3分27牙	13.4	2000PCS	M3X10
307	NYLON66/PC	29	3分27牙	M10	φ7.5	0.8	2000PCS	

### 201 歐規大內牙線扣

STRAIN RELIEF

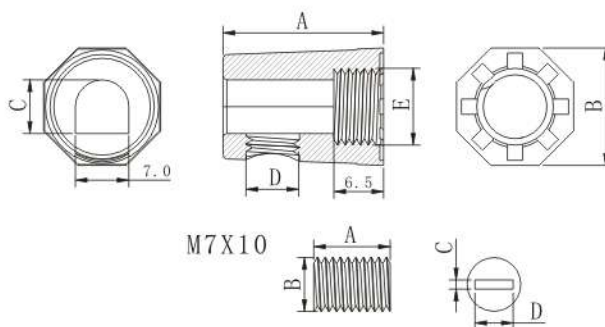

型號 ITEM NO	材質 MATERIAL	尺寸 (DIMENSIONS)					包裝 PACKING	備註 REMARK
		A	B	C	D	E		
ZG-201	NYLON66	21	15.3	7.0	M7	M10	2000PCS	
ZG-0710	PC	10	M7	1.7	5.0		2000PCS	

### 202 歐規大內牙線扣

STRAIN RELIEF

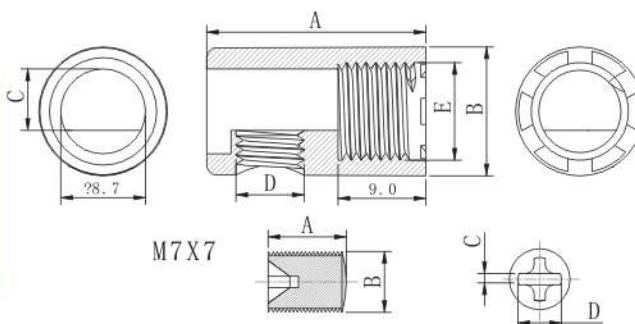

型號 ITEM NO	材質 MATERIAL	尺寸 (DIMENSIONS)					包裝 PACKING	備註 REMARK
		A	B	C	D	E		
ZG-202	NYLON66	22.5	∅13	6.0	M7	M10	2000PCS	
ZG-0707	PC	7.2	M7	1.3	5.0		2000PCS	

### 035 戒指扣

STRAIN RELIEF

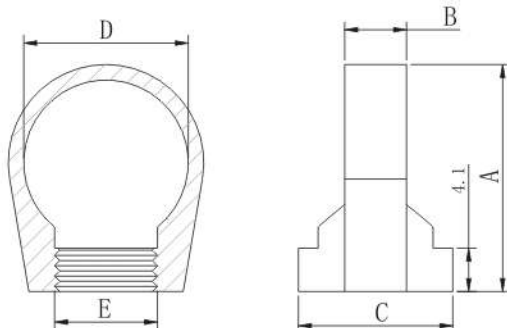

型號 ITEM NO	材質 MATERIAL	尺寸 (DIMENSIONS)					包裝 PACKING	備註 REMARK
		A	B	C	D	E		
035A	NYLON66	21.8	6.0	∅15	∅16.2	M10	2000PCS	
ZG-5227	NYLON66	14.3	8.4		∅9.5	M6	2000PCS	

## 006 吊燈線扣

PENDANT SIRAIN RELIEF



006SK

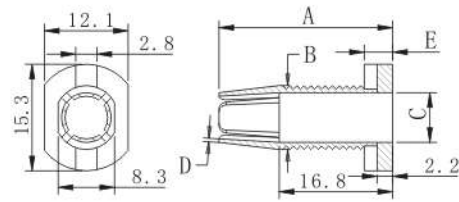

006S

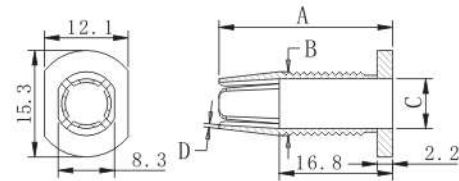

007C

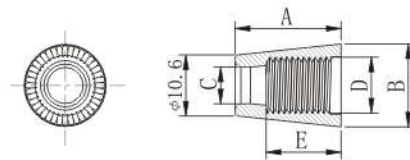

型號 ITEM NO	材質 MATERIAL	尺寸 (DIMENSIONS)					包裝 PACKING	備註 REMARK
		A	B	C	D	E		
ZG-007C	NYLON66/PC	19	∅14.8	∅6.5	M10	13.5	2000PCS	
ZG-006SK	NYLON66/PC	25	M10	∅7.4	1.2	3.7	2000PCS	有卡位
ZG-006S	NYLON66/PC	25	M10	∅7.4	1.2		2000PCS	

## 007 吊燈線扣

PENDANT SIRAIN RELIEF



007C-2  
007C-3

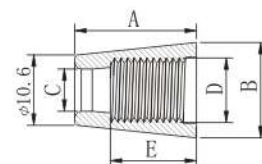
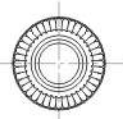

007S-2  
007S-3

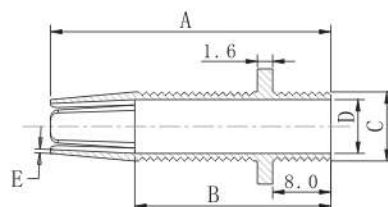
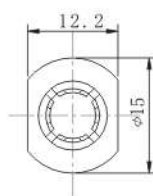

型號 ITEM NO	材質 MATERIAL	尺寸 (DIMENSIONS)					包裝 PACKING	備註 REMARK
		A	B	C	D	E		
ZG-007C-2	NYLON66/PC	19	∅14.8	∅6.5	M10	13.4	2000PCS	
ZG-007S-2	NYLON66/PC	29	20.9	M10	∅7.4	1.1	2000PCS	
ZG-007C-3	NYLON66/PC	19	∅14.8	∅7.5	M10	13.4	2000PCS	
ZG-007S-3	NYLON66/PC	29	20.9	M10	∅7.4	0.6	2000PCS	

### 033 吊燈線扣

PENDANT STRAIN RELIEF

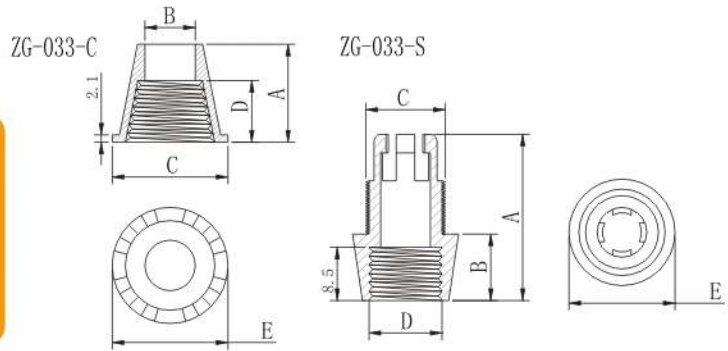

型號 ITEM NO	材質 MATERIAL	尺寸 (DIMENSIONS)					包裝 PACKING	備註 REMARK
		A	B	C	D	E		
ZG-033C	NYLON66/PC	13.2	∅7.0	M10	9.0	∅15.5	2000PCS	
ZG-033S	NYLON66/PC	22.5	∅9.5	M10	M10	∅15.5	2000PCS	
ZG-033C-3	NYLON66/PC	13.9	∅8.0	M10	9.0	∅15.5	2000PCS	

### 308 歐規大內牙線扣

STRAIN RELIEF

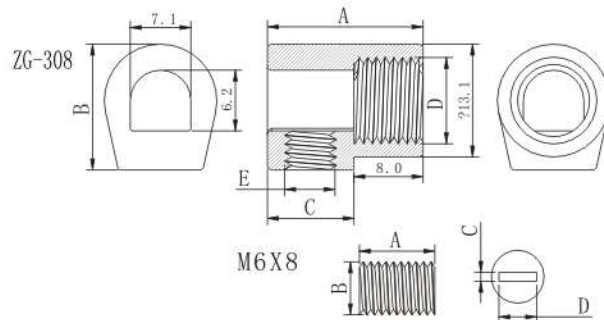

型號 ITEM NO	材質 MATERIAL	尺寸 (DIMENSIONS)					包裝 PACKING	備註 REMARK
		A	B	C	D	E		
ZG-308	NYLON66/PC	18	14.5	10	M10	M6	2000PCS	
ZG-0608	PC	8	M6	1.5	3.5		2000PCS	

### 005 卡線器

STRING CLIP

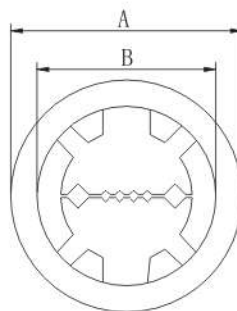
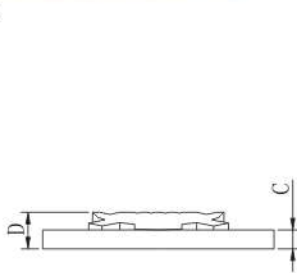

型號 ITEM NO	材質 MATERIAL	尺寸 (DIMENSIONS)				包裝 PACKING	備註 REMARK
		A	B	C	D		
ZG-005	PC	∅21.8	∅16.8	1.8	3.5	1000PCS	

### SWC-206 理綫器

WIRE CLIP

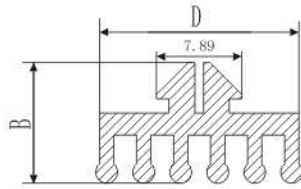
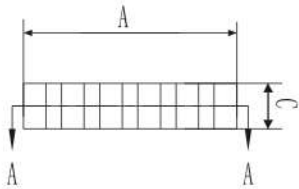

型號 ITEM NO	材質 MATERIAL	尺寸 (DIMENSIONS)					包裝 PACKING	備注 REMARK
		A	B	C	D	E		
SWC-206	NYLON66	19.13	11.13	4.05	18.42		2000PCS	

### 039/039-1 280綫扣

GRIPMASTER STRAIN RELIEF

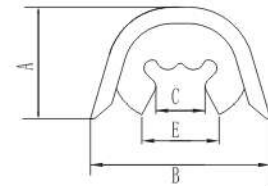
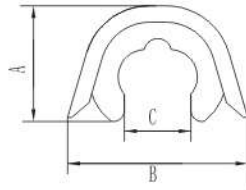

型號 ITEM NO	材質 MATERIAL	尺寸 (DIMENSIONS)					包裝 PACKING	備注 REMARK
		A	B	C	D	E		
039	STEEL+FIBRE	13.6	22	6	2.55	9.42	2000PCS	
039-1	STEEL+FIBRE	14.1	22	8.13	2.44		2000PCS	

### 004 電綫固定夾

CORD GRIPS

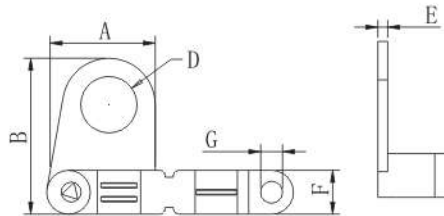

型號 ITEM NO	材質 MATERIAL	尺寸 (DIMENSIONS)							包裝 PACKING	螺絲 SCREW
		A	B	C	D	E	F	G		
ZG-004	NYLON66	20.5	30	14	∅10.5	1.6	8.0	∅3.7	1000PCS	M3X10
ZG-004A	NYLON66	20.5	30	14	∅13.5	1.6	8.0	∅3.7	1000PCS	M3X10
ZG-004B	NYLON66	21.1	31.5	12	∅10.5	1.4	8.0	∅3.5	1000PCS	M3X10

## 250 251 電線固定夾

CORD GRIPS



ZG-250  
ZG-251

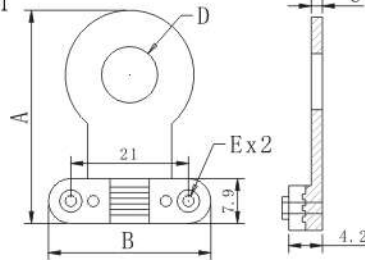

ZG-250AB

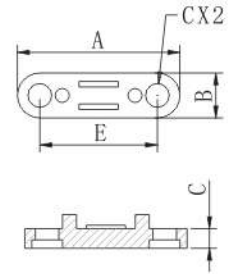

型號 ITEM NO	材質 MATERIAL	尺寸 (DIMENSIONS)					包裝 PACKING	螺絲 SCREW
		A	B	C	D	E		
ZG-250	NYLON66	37.8	29	2.0	∅11.2	∅2.1	500PCS	M3X7
ZG-251	NYLON66	37.8	29	2.0	∅14.0	∅2.1	500PCS	M3X7
ZG-250B	NYLON66	29	7.9	3.0	∅3.5	21	1000PCS	M3X7

## 351 電線固定夾

CORD GRIPS

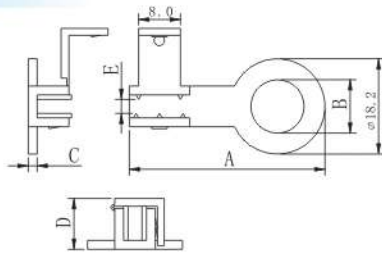

型號 ITEM NO	材質 MATERIAL	尺寸 (DIMENSIONS)					包裝 PACKING	備注 REMARK
		A	B	C	D	E		
ZG-351	NYLON66	37.5	∅10.3	1.7	9.5	2.4	1000PCS	

## 008 009 電線吊環

PENDEL PENDANTS



008

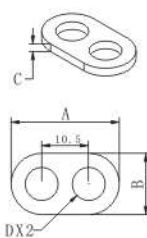

009

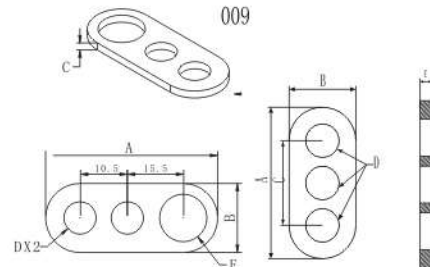

型號 ITEM NO	材質 MATERIAL	尺寸 (DIMENSIONS)					適用電線 Suitable Wires	包裝 PACKING
		A	B	C	D	E		
008-1	NYLON66	23.5	13	1.9	∅8.2		VDE, SPT-1, SPT-2	5000PCS
008	NYLON66	23.5	13	1.9	∅7		VDE, SPT-1, SPT-2	5000PCS
009	NYLON66	41	16.4	1.5	∅7.5	∅11.2	VDE, SPT-1, SPT-2	2000PCS
009A	PP	21.30	9.4	11.90	∅4.7	1.5	VDE, SPT-1, SPT-2	2000PCS
009-2	PP	40	16.0	2	∅6.8	∅11.2	VDE, SPT-1, SPT-2	2000PCS
009-3	PP	41.5	16.8	3	∅7.5	∅11.2	VDE, SPT-1, SPT-2	2000PCS

### 008A 兩孔塑膠墊片

TWO-HOLE PLASTIC WASHER

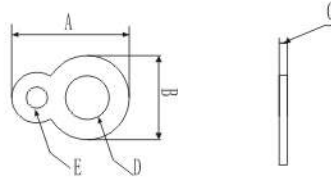

型號 ITEM NO	材質 MATERIAL	尺寸 (DIMENSIONS)					包裝 PACKING	備註 REMARK
		A	B	C	D	E		
008A	NYLON66	14	10	0.9	φ5.2	φ2.5	2000PCS	

### 092 電線吊環

PENDEL PENDANTS

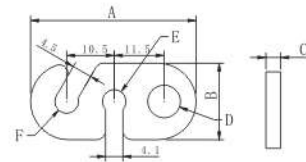

型號 ITEM NO	材質 MATERIAL	尺寸 (DIMENSIONS)						包裝 PACKING	備註 REMARK
		A	B	C	D	E	F		
092	NYLON66	38.5	17.8	3.3	φ7.7	φ5.4	φ5.4	1000PCS	

### ZG-86 理綫器

CABLE HOLDERS

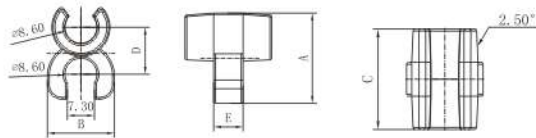

型號 ITEM NO	材質 MATERIAL	尺寸 (DIMENSIONS)					包裝 PACKING	備註 REMARK
		A	B	C	D	E		
ZG-86	PE	24.55	18	23.68	12.6	8.06	1000PCS	

### 管上固定鈎

PENDEL PENDANTS

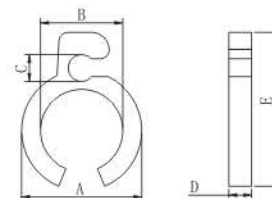

型號 ITEM NO	材質 MATERIAL	尺寸 (DIMENSIONS)					包裝 PACKING	備註 REMARK
		A	B	C	D	E		
NB-032	ABS / PC	φ19.6	φ12.6	φ6.0	5.2	27	5000PCS	
NB-033	ABS / PC	φ17.8	φ9.0	φ5.8	5.2	25.1	5000PCS	
NB-034	ABS / PC	φ21.9	φ15	φ6.0	5.2	27.6	1000PCS	
NB-035	ABS / PC	φ26.5	φ18.5	φ6.5	5.2	34	1000PCS	
NB-037	ABS / PC	φ11.2	φ6.5	φ2.0	4.1	14.5	1000PCS	
NB-038	ABS / PC	φ33	φ25	φ8.5	4.1	41.7	1000PCS	

### 094 PC 綫夾

CABLE CLAMPS

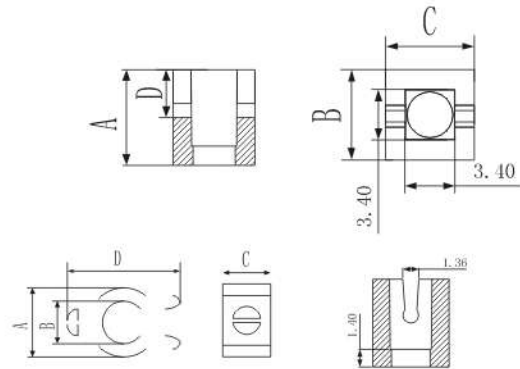

型號 ITEM NO	材質 MATERIAL	尺寸 (DIMENSIONS)					包裝 PACKING	備註 REMARK
		A	B	C	D	E		
094A	NYLON66	7.0	6.1	6.0	3.5		1000PCS	
094B	NYLON66	9.1	φ5.6	6.0	14.9		1000PCS	

### 093帶鈎綫扣

HOOK-LINE DEDUCTION

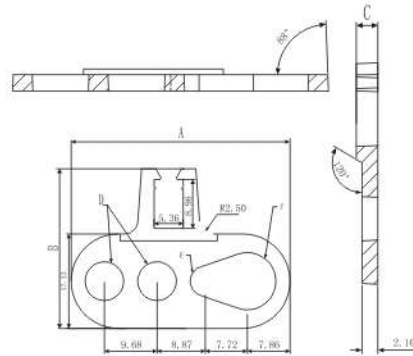

型號 ITEM NO	材質 MATERIAL	尺寸 (DIMENSIONS)					包裝 PACKING	備註 REMARK
		A	B	C	D	E		
ZG-093	PP	40.23	29.3	2.85	R7.1	R5.25	2000PCS	

### OCC-5 電綫束綫座

WIRE HOLDER

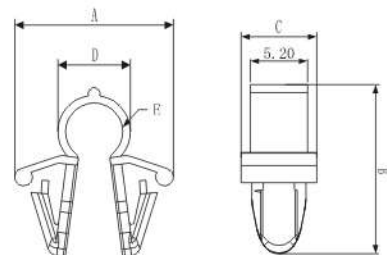

型號 ITEM NO	材質 MATERIAL	尺寸 (DIMENSIONS)						包裝 PACKING	備註 REMARK
		A	B	C	D	E	F		
OCC-5	NYLON66	14.4	15.33	6.9	φ6.6	φ5.2		3000PCS	

# 接綫盒（臺）及開關系列



## ZG-027 雙絕緣接線盒

DOUBLE-INSULATED WIRE CONNECTION BOX



ZG-027 A

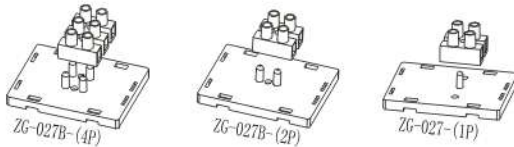
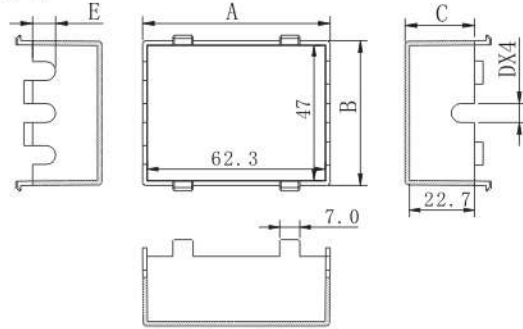

ZG-027 B(4P)

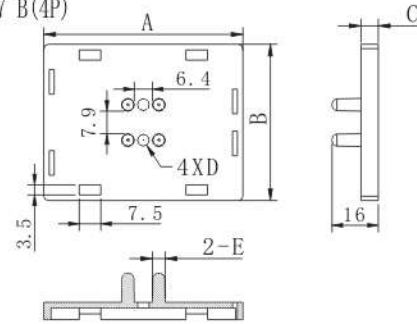

ZG-027B有3種款式，可根據需要裝2P或3P端子台。

The ZG-027B possess 3 kinds of styles, May pack on the basis of the necessities 2P either 3P's extremity.

型號 ITEM NO	材質 MATERIAL	尺寸 (DIMENSIONS)					包裝 PACKING	備註 REMARK
		A	B	C	D	E		
ZG-027A	NYLON66/ABS	65.3	50	24.2	6.5	8.0	100PCS	
ZG-027B	NYLON66/ABS	69.5	54.3	6.1	ø4.0	ø4.4	100PCS	

## ZG-028 雙絕緣接線盒

DOUBLE-INSULATED WIRE CONNECTION BOX



ZG-028 A

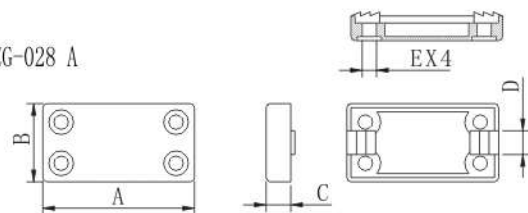

ZG-028 B

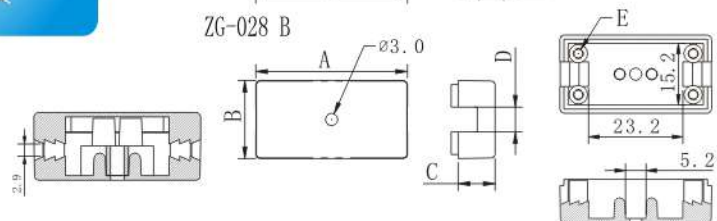

型號 ITEM NO	材質 MATERIAL	尺寸 (DIMENSIONS)					包裝 PACKING	螺絲 SCREW
		A	B	C	D	E		
ZG-028 A	NYLON66/ABS	37.5	19.2	6.1	5.8	ø3.5	200PCS	
ZG-028 B	NYLON66/ABS	37.5	19.2	9.0	6.1	ø2.5	200PCS	M3X10

### ZG-029 雙絕緣接線盒

DOUBLE-INSULATED WIRE CONNECTION BOX



ZG-029 A

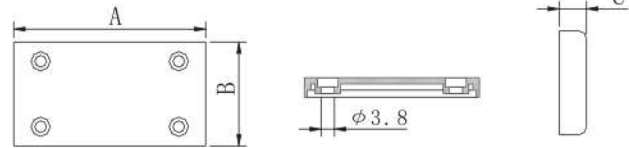

ZG-029 B

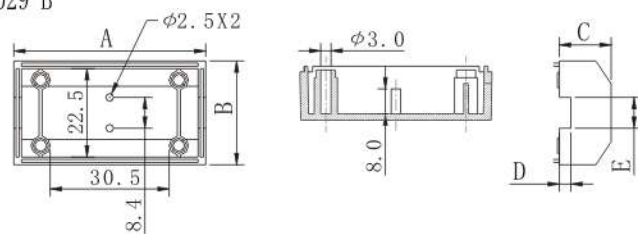

型號 ITEM NO	材質 MATERIAL	尺寸 (DIMENSIONS)					包裝 PACKING	螺絲 SCREW
		A	B	C	D	E		
ZG-029A	NYLON66/ABS	50	26.6	5.5			200PCS	
ZG-029B	NYLON66/ABS	50	26.6	12.6	3.0	7.8	200PCS	M3X10

### ZG-032 雙絕緣接線盒

DOUBLE-INSULATED WIRE CONNECTION BOX



ZG-032 A

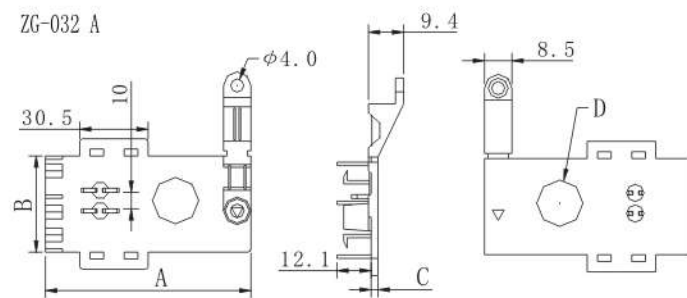

ZG-032 B

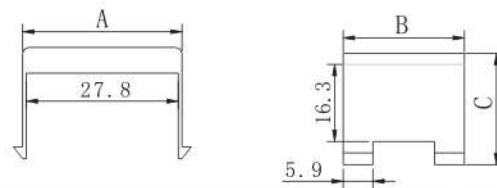

型號 ITEM NO	材質 MATERIAL	尺寸 (DIMENSIONS)					包裝 PACKING	螺絲 SCREW
		A	B	C	D	E		
ZG-032A	NYLON66	60.6	28.8	1.5	φ13.5		200PCS	
ZG-032B	NYLON66	30	22.3	21.2			200PCS	M3X10

### ZG-032-1/ZG-032-1A

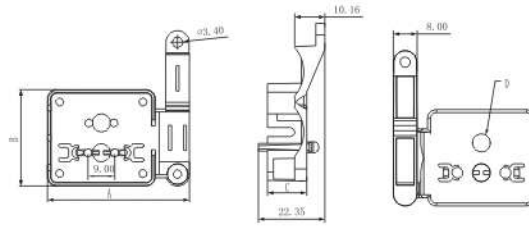

型號 ITEM NO	材質 MATERIAL	尺寸 (DIMENSIONS)					包裝 PACKING	螺絲 SCREW
		A	B	C	D	E		
ZG-032-1A	NYLON66	47.71	32.32	13.21	φ2.5		200PCS	M3X10
5448/4A	NYLON66	46.86	21.25	12.6	φ3		200PCS	M3X10

### ZG-032-1B

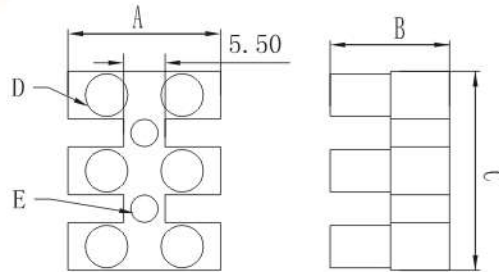

型號 ITEM NO	材質 MATERIAL	尺寸 (DIMENSIONS)					包裝 PACKING	螺絲 SCREW
		A	B	C	D	E		
ZG-032-1B	NYLON66	20.2	15.8	26.3	φ5.6	φ3.6	200PCS	

### ZG-032-1C

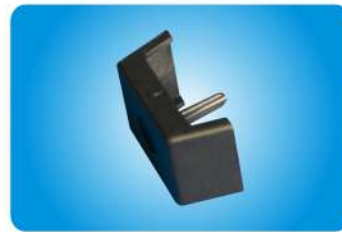
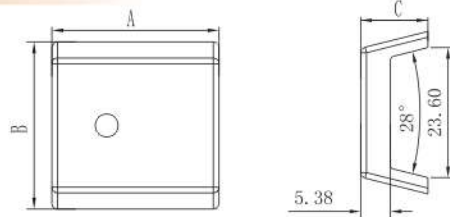

型號 ITEM NO	材質 MATERIAL	尺寸 (DIMENSIONS)					包裝 PACKING	螺絲 SCREW
		A	B	C	D	E		
ZG-032-1C	NYLON66	29.55	29.46	12.19			200PCS	
5448/4B	NYLON66	28.75	18.2	11.8			200PCS	

### ZG-032S

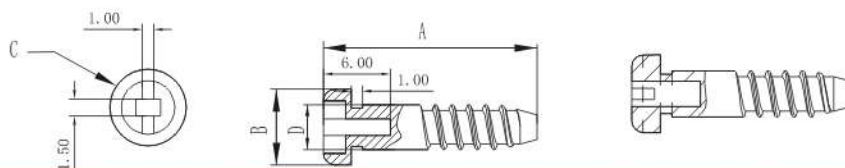

型號 ITEM NO	材質 MATERIAL	尺寸 (DIMENSIONS)					包裝 PACKING	螺絲 SCREW
		A	B	C	D	E		
ZG-032S	NYLON66	19.15	29.46	12.19			200PCS	

071 072 073 074 陶瓷端子臺

CERAMIC WIRE CONNECTOR SET

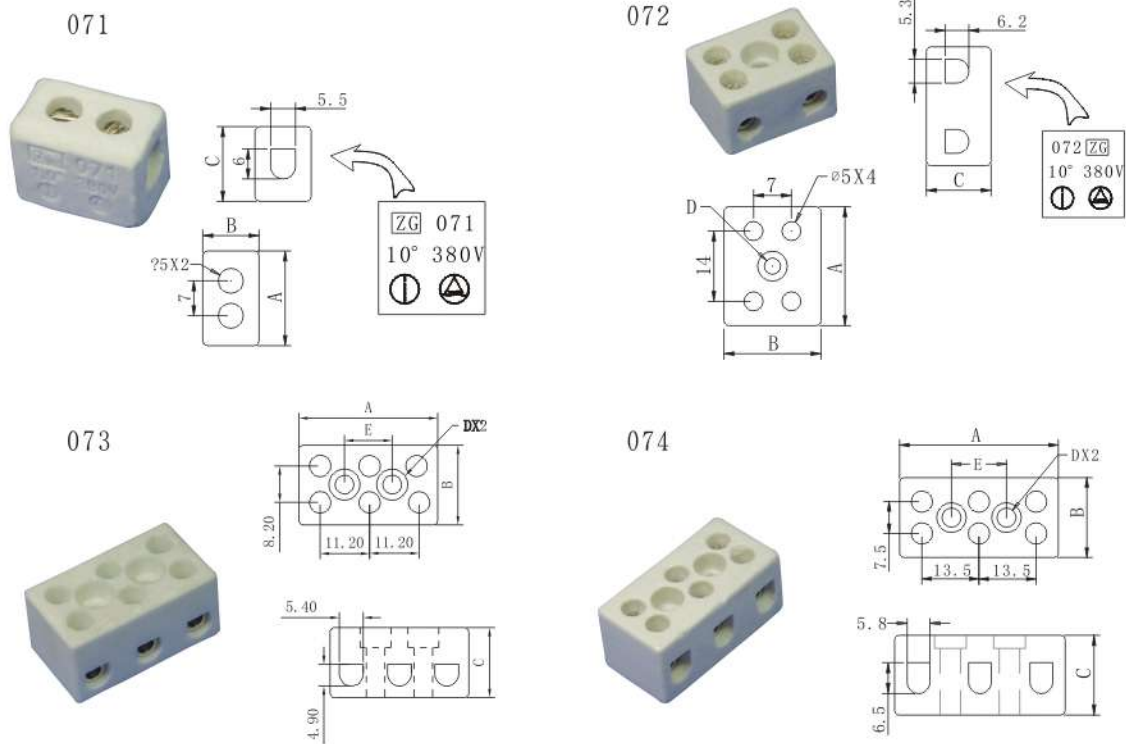

型號 ITEM NO	材質 MATERIAL	尺寸 (DIMENSIONS)					包裝 PACKING	備注 REMARK
		A	B	C	D	E		
071	CREAMICS	19	11.3	14			200PCS	TüV
072	CREAMICS	23.5	17.2	15	∅15.2		100PCS	TüV
073	CREAMICS	31.4	18	15.8	∅7.0	10.9	60PCS	
074	CREAMICS	37	18.8	17.5	∅4.5	13.5	60PCS	

173L 173S 173M 陶瓷接線帽

CERAMIC WIRE CONN CONNECTOR

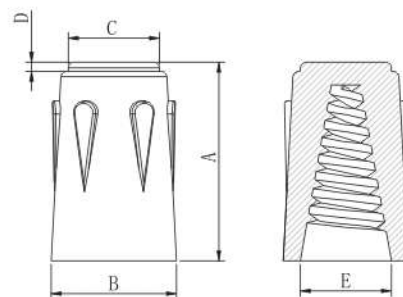

型號 ITEM NO	材質 MATERIAL	尺寸 (DIMENSIONS)					包裝 PACKING	備注 REMARK
		A	B	C	D	E		
173L	CREAMICS	24	∅15	∅10	2.0	∅11	1000PCS	
173M	CREAMICS	17.3	∅11	∅6.0	0.5	∅8.5	1000PCS	
173S	CREAMICS	14.5	∅9.0	∅5.2	1.0	∅7.0	1000PCS	



# 保護套系列



### 013E 歐式降落傘

SOCKET BUSHING

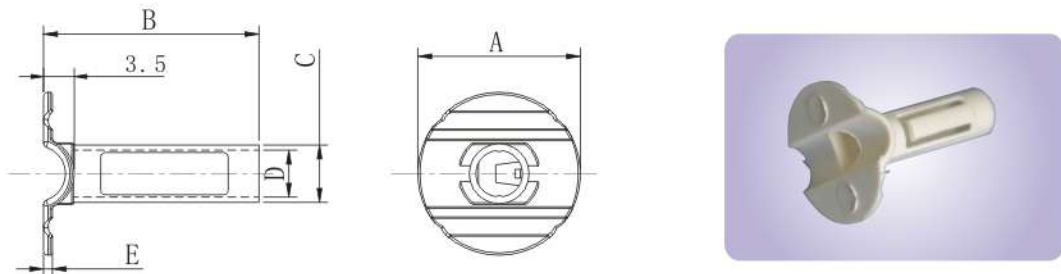

型號 ITEM NO	材質 MATERIAL	尺寸 (DIMENSIONS)					包裝 PACKING	備注 REMARK
		A	B	C	D	E		
ZG-013E	NYLON66 / PE	∅18.3	24.7	∅6.5	∅5.4	1.0	1000PCS	

### 022 023 鎖式降落傘

SOCKET BUSHING

ZG-022

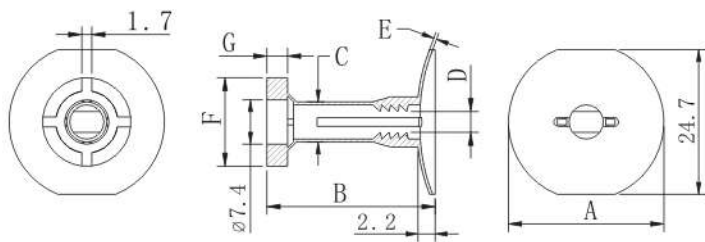

ZG-023

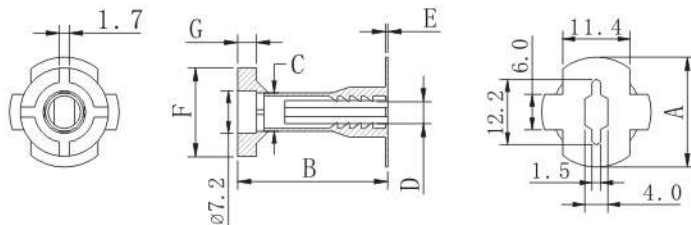

型號 ITEM NO	材質 MATERIAL	尺寸 (DIMENSIONS)							包裝 PACKING
		A	B	C	D	E	F	G	
ZG-022	POM	∅26.4	28	∅6.8	3.5	0.5	∅14.8	3.5	1000PCS
ZG-023	POM	∅18.6	26	∅6.5	4.0	0.4	∅14.9	3.2	1000PCS

### 012 013 降落傘

SOCKET BUSHING

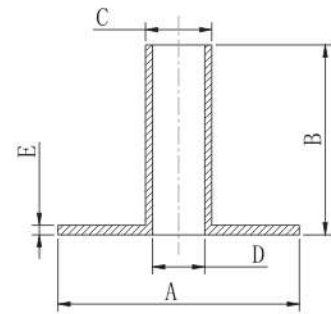

型號 ITEM NO	材質 MATERIAL	尺寸 (DIMENSIONS)					包裝 PACKING	備注 REMARK
		A	B	C	D	E		
ZG-012	PE	φ24.8	19.2	φ6.8	φ5.8	1.0	2000PCS	
ZG-012B	PE	φ20.8	20.5	φ6.8	φ5.8	1.1	2000PCS	
ZG-012D	PE	φ24.8	25	φ6.8	φ5.8	1.1	2000PCS	
ZG-012H	NYLON66	φ25	19.2	φ6.8	φ5.8	1.1	2000PCS	
ZG-013	PE	φ15.5	18.5	φ6.9	φ5.9	1.0	2000PCS	
ZG-013D	PE	φ19.5	14.6	φ9.9	φ8.9	1.0	2000PCS	
ZG-013H	NYLON66	φ15.5	19.5	φ6.9	φ5.9	1.1	2000PCS	
ZG-013K	PE	φ18.5	20.1	φ6.8	φ5.8	1.0	2000PCS	
ZG-013L	NYLON66	φ20	19	φ6.8	φ5.8	1.1	2000PCS	
ZG-012A	PE	φ24.8	19.5	φ6.8	φ5.8	0.9	2000PCS	
ZG-013A	PE	φ16	19	φ6.7	φ5.9	1.0	2000PCS	
103293	NYLON66	φ15	20.8	φ6.6	φ5.3	0.6	2000PCS	
TD-1708	NYLON66	φ17	13.2	φ8.9	φ8	1.1	2000PCS	
XB-251203	NYLON66	φ25	15.1	φ13.4	φ10.6	3	2000PCS	
XB-200603	NYLON66	φ20	9.1	φ8.5	φ6.5	3	2000PCS	
XB-201003	NYLON66	φ19.9	13.1	φ10.4	φ8.5	3	2000PCS	

### 053 帶尾巴降落傘

SOCKET BUSHING

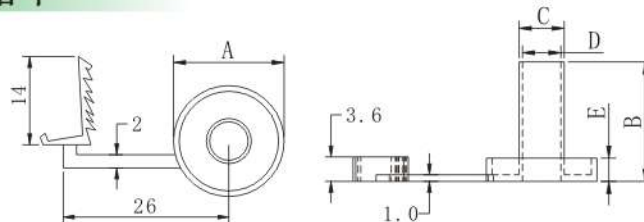

型號 ITEM NO	材質 MATERIAL	尺寸 (DIMENSIONS)					包裝 PACKING	備注 REMARK
		A	B	C	D	E		
053	NYLON66/PE	φ16.7	18	φ7.0	φ6.0	3.5	500PCS	

### 013J 燈頭保護套

SOCKET BUSHING

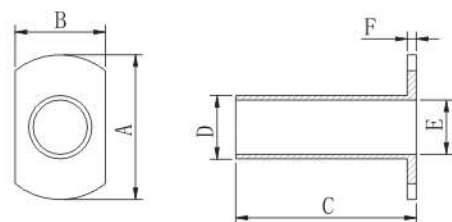

型號 ITEM NO	材質 MATERIAL	尺寸 (DIMENSIONS)						包裝 PACKING
		A	B	C	D	E	F	
013J	NYLON66/PE	φ16	10	20	φ7	φ6	1.0	1000PCS

### 012C 013C 凸型降落傘

SOCKET BUSHING

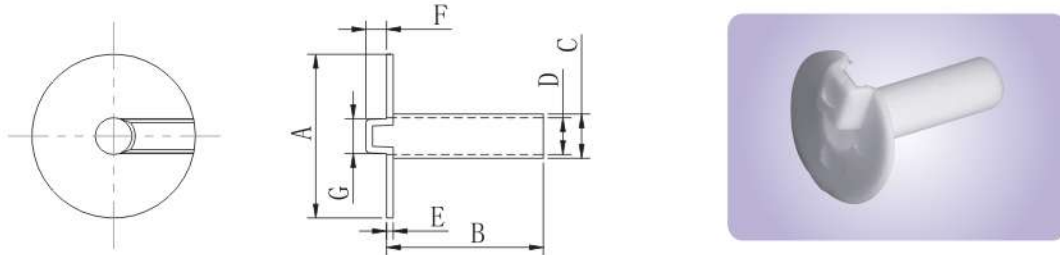

型號 ITEM NO	材質 MATERIAL	尺寸 (DIMENSIONS)							包裝 PACKING
		A	B	C	D	E	F	G	
012C	PE	∅24.5	22.5	∅6.5	∅5.5	1.0	3.0	6.0	1000PCS
013C	PE	∅16	21.2	∅6.3	∅5.4	1.0	2.8	5.8	2000PCS

### 081A 081B 出線護套

SHELTET SUIT

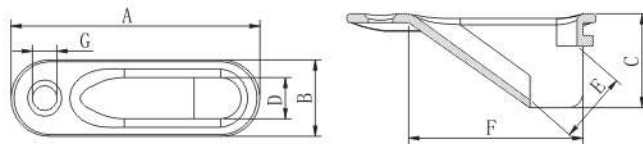

型號 ITEM NO	材質 MATERIAL	尺寸 (DIMENSIONS)							包裝 PACKING	備註 REMARK
		A	B	C	D	E	F	G		
ZG-081A	NYLON66/PC	42.5	13	15.5	7.0	12.3	29	∅4.4	500PCS	
ZG-081B	NYLON66/PC	32	10	13	4.2	8.5	23	∅4.2	2000PCS	

### 017 插頭保護套

HOUSING COVER

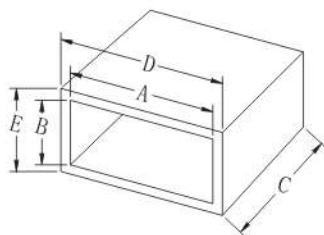

型號 ITEM NO	材質 MATERIAL	尺寸 (DIMENSIONS)					包裝 PACKING	備註 REMARK
		A	B	C	D	E		
ZG-017	PVC / PE	15	7	18.5	17	9	1000PCS	
017	PVC / PE	14.5	7.6	17.5	16	9	1000PCS	

## 055 插頭保護套

HOUSING COVER



055A

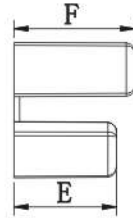
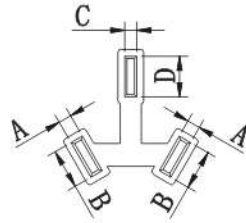

055B

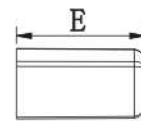
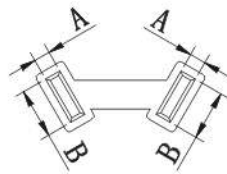

055-1

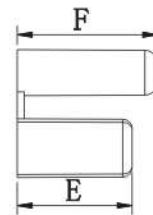
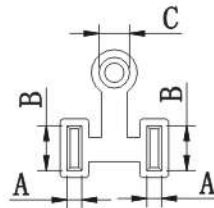

055

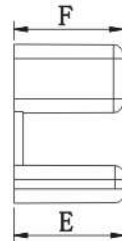
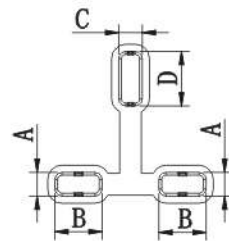

ZG-T5

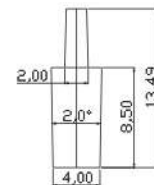
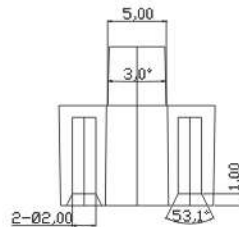

型號 ITEM NO	材質 MATERIAL	尺寸 (DIMENSIONS)						包裝 PACKING	備注 REMARK
		A	B	C	D	E	F		
055B	PE	2.5	7.0			17.8		1000PCS	
055A	PE	2.5	7.0	2.5	7.5	18	21.2	1000PCS	
055	PE	5.8	8.5	5.5	10	18	23	1000PCS	
055-1	PE	2.2	7.1	∅4.8		18	22	1000PCS	
ZG-T5	PE	13.49	13.7	5.0	∅2	∅2	9.0	1000PCS	

## ZG-077 溫控護套

SHELTET SUIT

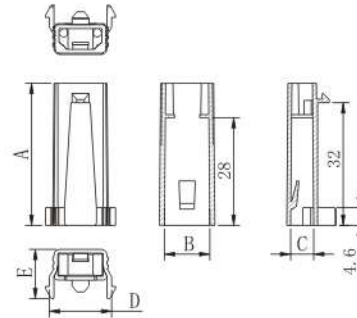

作用：用於保護溫度保險絲。

Action : Used to safeguard the temperature fuse-wire.

型號 ITEM NO	材質 MATERIAL	尺寸 (DIMENSIONS)					包裝 PACKING	備註 REMARK
		A	B	C	D	E		
ZG-077	NYLON66	37	12	6.2	16.2	12.9	1000PCS	

## 牙管護套

PIPE HOLE BUSHINGS

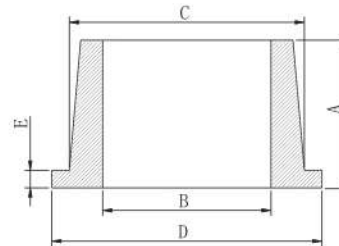

型號 ITEM NO	材質 MATERIAL	尺寸 (DIMENSIONS)					包裝 PACKING	備註 REMARK
		A	B	C	D	E		
014	PE	7.5	φ6.0	φ7.0	φ8.0	0.5	10000PCS	
014-1	PE	6.5	φ6.0	φ6.8	φ8.0	0.5	10000PCS	
014A	PE	4.5	φ5.0	φ5.8	φ8.0	0.7	10000PCS	
014B	PE	9.0	φ6.5	φ7.5	φ9.5	2.0	10000PCS	
014C	PE	10.8	φ6.0	φ7.0	φ8.5	3.7	10000PCS	
014D	PE	14	φ6.0	φ7.0	φ8.5	1.8	10000PCS	
014D-1	PE	12	φ6.0	φ7.2	φ8.2	1.8	10000PCS	
014E	PE	7.5	φ4.0	φ5.5	φ6.5	1.7	10000PCS	
014F	PE	7.5	φ4.5	φ5.3	φ6.0	0.6	1000PCS	
014H	PE	7.5	φ4.5	φ5.5	φ6.5	0.7	1000PCS	
014W	PE	9.5	φ5.5	φ6.8	φ9.0	1.8	2000PCS	
015	PE	10.5	φ8.5	φ9.2	φ10	1.0	2000PCS	
015A	PE	10.1	φ8.0	φ9.0	φ10	0.5	2000PCS	
016	PE	11	φ9.5	φ10.5	φ12	1.3	2000PCS	
016-1	PE	10.5	φ11	φ12	φ14	1.0	2000PCS	
016A	PE	10.6	φ8.5	φ10	φ11.5	1.0	2000PCS	
016D	PE	10	φ10	φ11	φ12.5	1.0	2000PCS	
016E	PE	14	φ12	φ14	φ15	1	1000PCS	
016F	PE	15.8	φ12.9	φ15	φ17	1.6	1000PCS	
016F-1	PE	16	φ12.5	φ15	φ16.5	1.6	1000PCS	
016E-1	PE	14	φ11.5	φ13	φ14.5	1.0	1000PCS	
016-3	PE	10	φ11	φ12	φ13.5	1.0	1000PCS	

## U型管護套

U-TUBE SHEATH

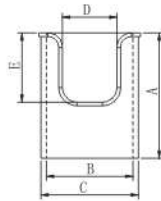

型號 ITEM NO	材質 MATERIAL	尺寸 (DIMENSIONS)					包裝 PACKING	備注 REMARK
		A	B	C	D	E		
056	PE	17.2	∅11.5	∅13.5	7.5	10.3	1000PCS	
057	PE	20	∅10	∅11.5	7.0	10.3	1000PCS	
058	PE	19.8	∅7.4	∅9.4	5.5	9	2000PCS	

## 護綫套

GROMMET

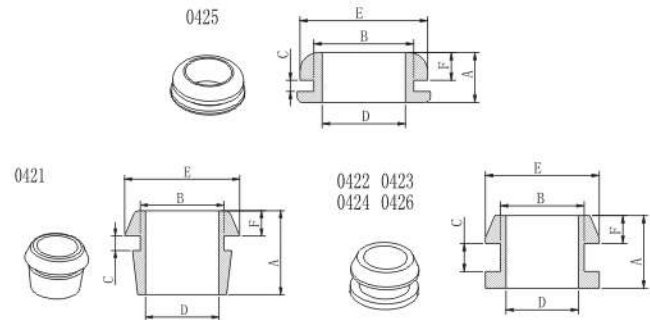

型號 ITEM NO	材質 MATERIAL	尺寸 (DIMENSIONS)						包裝 PACKING	備注 REMARK
		A	B	C	D	E	F		
0421	PVC	8.0	∅8.0	1.2	∅7.0	∅11.0	2.0	2000PCS	
0422	PVC	6.0	∅9.5	2.6	∅8.0	∅13	2.5	2000PCS	
0423	PVC	6.5	∅11.5	2.0	∅9.0	∅16.5	2.5	2000PCS	
0424	PVC	6.5	∅7.5	2.6	∅6.0	∅10.5	2.5	2000PCS	
0425	PVC	4.8	∅10	1.0	∅8.0	∅12.0	2.5	2000PCS	
0426	PVC	6.5	∅7.5	2.5	∅6.0	∅10.5	2.5	2000PCS	
0425A	TPR	4.7	∅9	1.2	∅7.6	∅12	2.5	2000PCS	

## 0428护线环

GROMMET

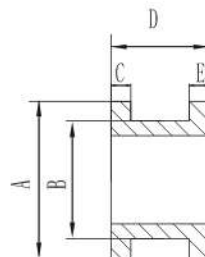
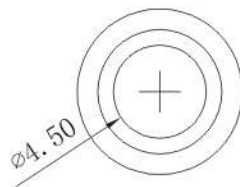

型號 ITEM NO	材質 MATERIAL	尺寸 (DIMENSIONS)					包裝 PACKING	備注 REMARK
		A	B	C	D	E		
0428	PVC	∅8.0	∅6.0	1.0	5	1	2000PCS	

010 011 鐵管護套

TUBE PROTECTOR PROTEC

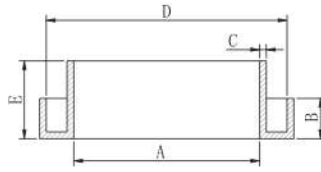

型號 ITEM NO	材質 MATERIAL	尺寸 (DIMENSIONS)					包裝 PACKING	備註 REMARK
		A	B	C	D	E		
010	PE	∅30	6.0	1.1	∅37	10.5	200PCS	
011	PE	∅20	6.0	1.1	∅25.4	11	1000PCS	

車輪

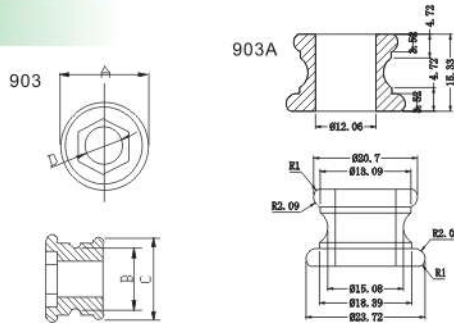

型號 ITEM NO	材質 MATERIAL	尺寸 (DIMENSIONS)						包裝 PACKING	備註 REMARK
		A	B	C	D	E	F		
903	ABS	15.25	23.6	20.6	15	10.5		1000PCS	
903A	ABS	15.7	23.2	20.7	15	11		1000PCS	

046 出線護套

SHELTET SUIT



046/7

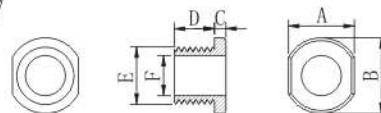

046/20

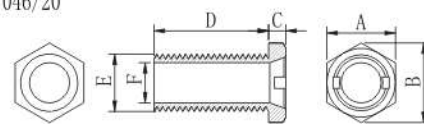

046

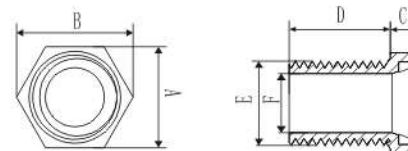
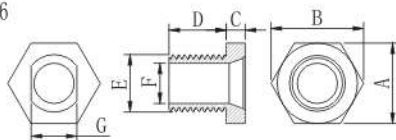

型號 ITEM NO	材質 MATERIAL	尺寸 (DIMENSIONS)							包裝 PACKING	備註 REMARK
		A	B	C	D	E	F	G		
046	NYLON66/PC	14	15.8	13.4	10	M10	∅7.0	8.2	2000PCS	半牙螺絲式
046/7	NYLON66/PC	12.2	∅12.3	2.0	7.0	M10	∅7.0		2000PCS	全牙螺絲式
046/20	NYLON66/PC	12	13.6	3.0	20.2	M10	∅7.0		2000PCS	全牙螺絲式
046/15	PA66	12	13.86	3	12	M10	∅7.0		2000PCS	全牙螺絲式

### 046A M10螺絲

M10 SCREW

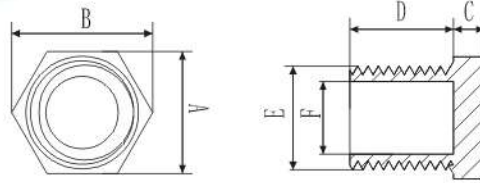

型號 ITEM NO	材質 MATERIAL	尺寸 (DIMENSIONS)						包裝 PACKING	備註 REMARK
		A	B	C	D	E	F		
046A	NYLON66	11.8	13.63	3	10	M10	φ7.0	2000PCS	全牙螺絲式
046A-B	NYLON66	11.85	13.68	3.1	7.0	M10	φ7.15	2000PCS	全牙螺絲式

### 913 開口護套

OPEN JACKET

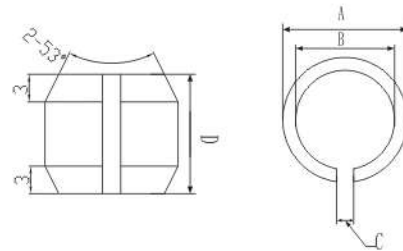

型號 ITEM NO	材質 MATERIAL	尺寸 (DIMENSIONS)					包裝 PACKING	備註 REMARK
		A	B	C	D	E		
913	POM	φ14.5	φ11.50	2	13		500PCS	

### 920 051 052 護套

OPEN JACKET

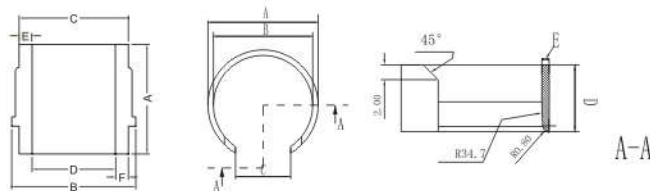

型號 ITEM NO	材質 MATERIAL	尺寸 (DIMENSIONS)					包裝 PACKING	備註 REMARK
		A	B	C	D	E		
920	POM	φ20	φ18	10	9	1	500PCS	
051	PE	8.5	φ11	φ9.5	φ7	1	1000PCS	
052	PE	11.5	φ14	φ12	φ9.5	1.2	1000PCS	

### 926 開口護套

OPEN JACKET

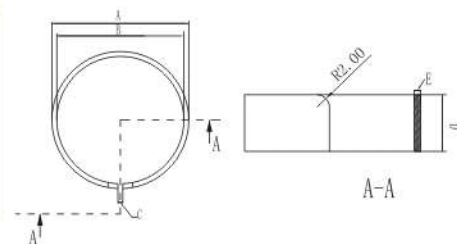

型號 ITEM NO	材質 MATERIAL	尺寸 (DIMENSIONS)					包裝 PACKING	備註 REMARK
		A	B	C	D	E		
926	POM	φ28	φ26	1	9	1	500PCS	
P1186-B-1	PE	φ31.2	φ28	2	8	3.2	500PCS	
P1121-1	PE	φ17.6	φ15.0	2	8	2.6	500PCS	

045 護線套  
SNAP BUSHING

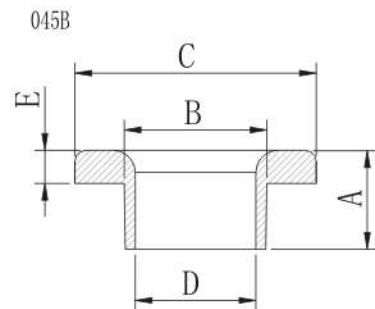
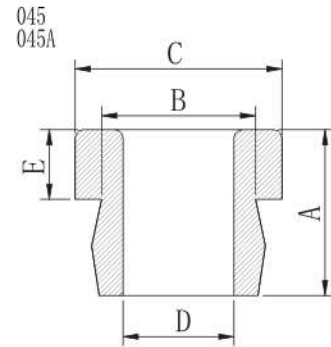

型號 ITEM NO	材質 MATERIAL	尺寸 (DIMENSIONS)					包裝 PACKING	備注 REMARK
		A	B	C	D	E		
045	NYLON66	10	∅9.5	∅12.5	∅6.7	4.1	2000PCS	
045A	NYLON66	6.0	∅9.0	∅12	∅7.0	2.1	2000PCS	
045B	NYLON66	4.5	∅6.5	∅11	∅5.5	1.5	2000PCS	
045C	PE	6.5	∅10	∅12.7	∅7.0	2.4	2000PCS	

931 開口護套  
SHELTERS SUIT

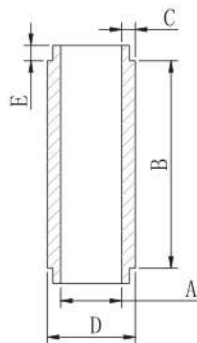

型號 ITEM NO	材質 MATERIAL	尺寸 (DIMENSIONS)					包裝 PACKING	備注 REMARK
		A	B	C	D	E		
931	PP	∅9.5	27	1.0	∅11.5	1.5	500PCS	
921	PP	∅9.0	16	1.3	∅11.4	2.0	500PCS	

# 墊片、五金端子系列



方型絕緣片

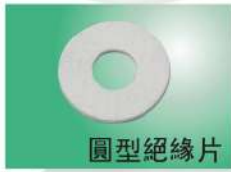

圓型絕緣片

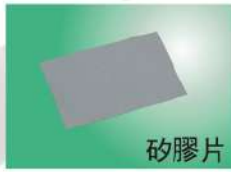

矽膠片



DH6-8



DH6-10

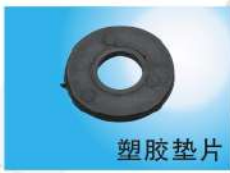

塑膠墊片

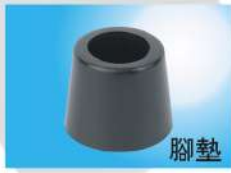

腳墊



弧型壓片

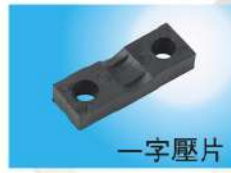

一字壓片



503



507



501



501B



502



506



504



505A



505B



505C



040



103293



TD-1708



XB-200603



XB-201003



XB-251203

### 絕緣片 (雙孔)

PAPER INSULATED PAD



型號 ITEM NO	材質 MATERIAL	尺寸 (DIMENSIONS)					包裝 PACKING
		A	B	C	D	E	
411	Pibre	34	26	∅3.5	1.0	8.0	2000PCS
412	Pibre	40	33	∅3.2	0.8	10	2000PCS
413	Pibre	50	34	∅3.5	0.8	8.0	2000PCS
414	Pibre	32	32	∅3.5	1.0	8.0	2000PCS
415	Pibre	25	20	∅3.5	1.0	8.0	2000PCS
419	Pibre	36	36	∅3.5	1.0	10	2000PCS

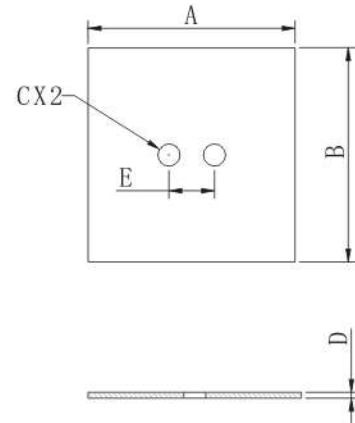

### 絕緣片 (單孔)

PAPER INSULATED PAD



型號 ITEM NO	材質 MATERIAL	尺寸 (DIMENSIONS)				包裝 PACKING
		A	B	C	D	
410	Pibre	33	40	∅4.0	1.0	2000PCS
410A	Pibre	36	30	∅4.0	0.8	2000PCS
410B	Pibre	34	32.8	∅3.5	0.8	2000PCS
410S	Pibre	29	26	∅3.5	0.8	2000PCS
412A	Pibre	40	34	∅3.5	0.8	2000PCS
415A	Pibre	20	10	∅3.8	1.0	2000PCS
416	Pibre	23.5	16	∅4.0	1.0	2000PCS
418	Pibre	45	40	∅5.0	1.0	2000PCS

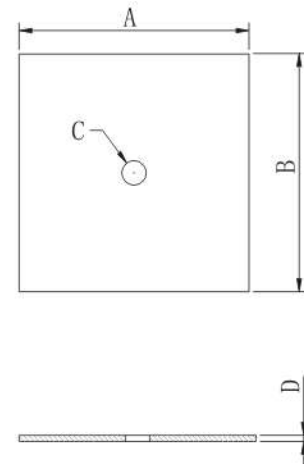

### 絕緣片 (圓形)

PAPER INSULATED PAD



型號 ITEM NO	材質 MATERIAL	尺寸 (DIMENSIONS)			包裝 PACKING
		A	B	C	
WR-200801J	Pibre	∅20	∅8	1.0	2000PCS
WR-18130.8J	Pibre	∅18	∅13	0.8	2000PCS
WR-08040.5J	Pibre	∅8	∅4	0.5	2000PCS
WR-08040.8J	Pibre	∅8	∅4	0.8	2000PCS

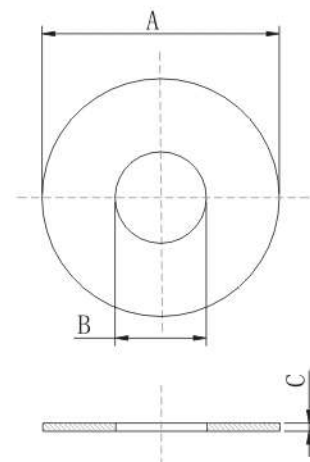

## 矽膠片

SILICON GUM

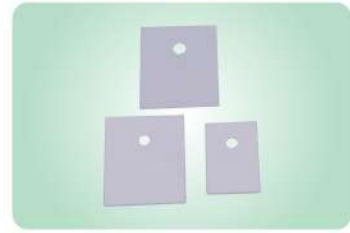
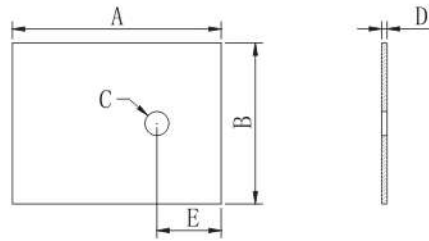

型號 ITEM NO	材質 MATERIAL	尺寸 (DIMENSIONS)					包裝 PACKING	備註 REMARK
		A	B	C	D	E		
XJ6040	Silicon gum	60	40		0.3		2000PCS	無孔
XJ2520	Silicon gum	25	20	∅3.0	0.3	8.0	2000PCS	
XJ2013	Silicon gum	20	13	∅3.0	0.3	5.0	2000PCS	

## 蜈蚣爪墊片

SPACER

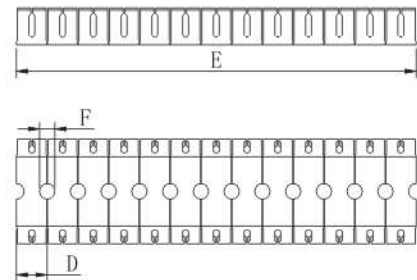
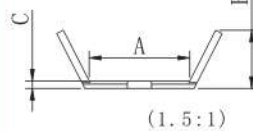

型號 ITEM NO	材質 MATERIAL	尺寸 (DIMENSIONS)							包裝 PACKING
		A	B	C	D	E	F	段數	
DH12-8	ABS / NYLON66	16	9	1.0	8.0	97	∅4.0	12	1000PCS
DH6-10	ABS / NYLON66	21	9.5	1.0	10	60	∅4.0	6	1000PCS
DH6-8	ABS / NYLON66	35	9.0	1.2	9.3	56	∅6.0	6	1000PCS

## 馬蹄形腳墊

HOOF FORM SPACER

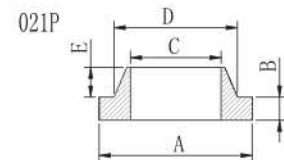
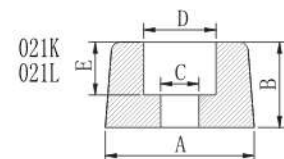
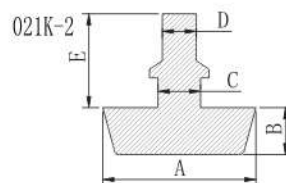

型號 ITEM NO	材質 MATERIAL	尺寸 (DIMENSIONS)					包裝 PACKING	備註 REMARK
		A	B	C	D	E		
021K	PVC / 硅膠	∅17.5	14	∅4.2	∅9.0	9.2	1000PCS	
021L	PVC / 硅膠	∅17.5	10	∅4.5	∅8.5	6.2	1000PCS	
021K-2	PVC / 硅膠	∅17.5	5.8	∅5.5	∅4.0	10.5	1000PCS	
021P	PVC / 硅膠	∅18	2.7	∅10.5	∅14	3.3	1000PCS	
021H-3	橡膠	∅16.2	8				500PCS	
021H-5	橡膠	∅16.5	9				500PCS	

## 墊片 SPACER

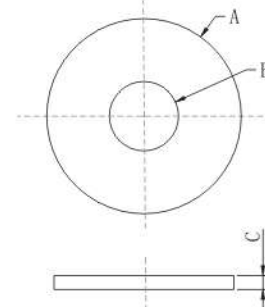

型號 ITEM NO	尺寸 (DIMENSIONS)			包裝 PACKING	備注 REMARK
	A	B	C		
WR-050301	φ5	φ3	1.0	2000PCS	
WR-05031.5	φ4.9	φ3.1	1.5	2000PCS	
WR-060302	φ6.0	φ3.0	2	2000PCS	
WR-080401	φ8	φ4	1.0	2000PCS	
WR-080402	φ8	φ4	2.0	2000PCS	
WR-100401	φ10	φ4	1.0	2000PCS	
WR-100402	φ10	φ4	2.0	2000PCS	
WR-100501	φ10	φ5	1.0	2000PCS	
WR-100502	φ10	φ5	2.0	2000PCS	
WR-138.20.5	φ13.3	φ8.3	0.5	2000PCS	
WR-150501	φ15	φ5	1.0	2000PCS	
WR-150702	φ15	φ7	2.0	2000PCS	
WR-151001	φ15	φ10	1.0	2000PCS	
WR-151002	φ15	φ10	2.0	2000PCS	
WR-161002	φ16	φ10	1.0	2000PCS	
WR-185.21.5	φ18	φ5.2	1.5	2000PCS	
WR-18101.5	φ18	φ10	1.5	2000PCS	
WR-181103	φ18	φ11	3.0	2000PCS	
WR-19071.6	φ19	φ7	1.6	2000PCS	
WR-201001	φ20	φ10	1.0	2000PCS	
WR-201002	φ20	φ10	2.0	2000PCS	
WR-201302	φ20	φ13	2.0	2000PCS	
WR-220402	φ22	φ4	2.0	2000PCS	
WR-221302	φ22	φ13	2.0	2000PCS	
WR-250902	φ25	φ9	2.0	2000PCS	
WR-251002	φ25	φ10	2.0	2000PCS	
WR-251302	φ25	φ13	2.0	2000PCS	
WR-261402	φ26	φ14	2.0	2000PCS	
WR-301002	φ30	φ10	2.0	2000PCS	
WR-351301	φ35	φ13	1.0	2000PCS	
WR-531002	φ53	φ10	2.0	2000PCS	

注:備有PE, 尼龍,PVC, 硅膠等各種材質及透明, 白色, 黑色等顏色。

Notes: There are the different material character and transparent such as PE silica gel and so on, White, Colours such as black and so on.

501 501A 地線端子  
GROUNDING CONNECTOR

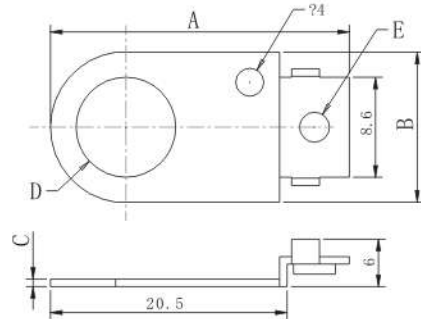

型號 ITEM NO	材質 MATERIAL	尺寸 (DIMENSIONS)					包裝 PACKING	螺絲 SCREW
		A	B	C	D	E		
501	STEEL	31	15.3	0.8	∅10	$\frac{5}{32}$ "牙	2000PCS	$\frac{5}{32}$ "X4
501A	STEEL	31	15.3	0.8	∅13	$\frac{5}{32}$ "牙	2000PCS	$\frac{5}{32}$ "X4

501B 地線端子  
GROUNDING CONNECTOR

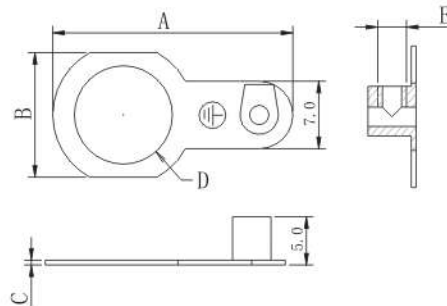

型號 ITEM NO	材質 MATERIAL	尺寸 (DIMENSIONS)					包裝 PACKING	螺絲 SCREW
		A	B	C	D	E		
501B	COPPER	25.2	14.7	0.5	∅10.2	$\frac{3}{32}$ "牙	2000PCS	$\frac{3}{32}$ "X5

502 502A 地線端子  
GROUNDING CONNECTOR

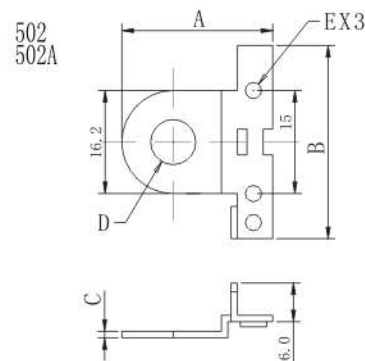

型號 ITEM NO	材質 MATERIAL	尺寸 (DIMENSIONS)					包裝 PACKING	螺絲 SCREW
		A	B	C	D	E		
502	STEEL	32	30	1.0	∅10	$\frac{1}{8}$ "牙	500PCS	$\frac{1}{8}$ "X $\frac{3}{8}$ " $\frac{1}{8}$ "X5.5
502A	STEEL	32	30	1.0	∅13	$\frac{1}{8}$ "牙	500PCS	$\frac{1}{8}$ "X $\frac{3}{8}$ " $\frac{1}{8}$ "X5.5

504 504A 地線端子  
GROUNDING CONNECTOR



504 504A 接地片  
PAMP

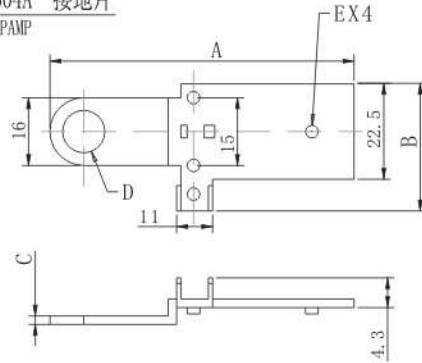

072 陶瓷接線座  
CERAMIC WIRE CONNECTOR SET

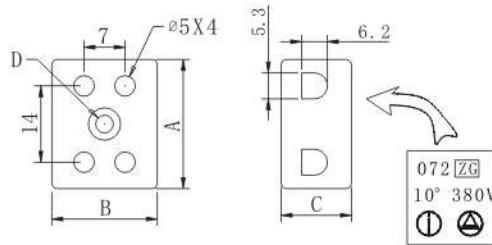
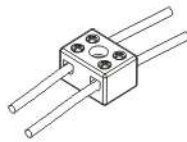

型號 ITEM NO	材質 MATERIAL	尺寸 (DIMENSIONS)					包裝 PACKING	螺絲 SCREW
		A	B	C	D	E		
504	STEEL	68	30	1.0	∅10	1/8"牙	500PCS	1/8"X5.5 1個 1/8"X15 1個 1/8"X3 2個
504A	STEEL	68	30	1.0	∅13.2	1/8"牙	500PCS	
072	CREAMICS	23.5	17.2	15	∅15.2		100PCS	
026	NYLON66	22	7.1	1.7	∅3.5	15	5000PCS	
410A	Pibre	36	30	0.	∅4.0		2000PCS	

503 503A 地線端子  
GROUNDING CONNECTOR

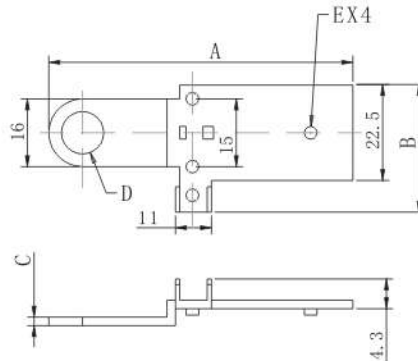

型號 ITEM NO	材質 MATERIAL	尺寸 (DIMENSIONS)					包裝 PACKING	螺絲 SCREW
		A	B	C	D	E		
503	STEEL	68	30	1.0	∅10	1/8"牙	500PCS	1/8"X5.5 1個 1/8"X3 2個
503A	STEEL	68	30	1.0	∅13.2	1/8"牙	500PCS	

## 026 壓線片

LINE BALL SLICE

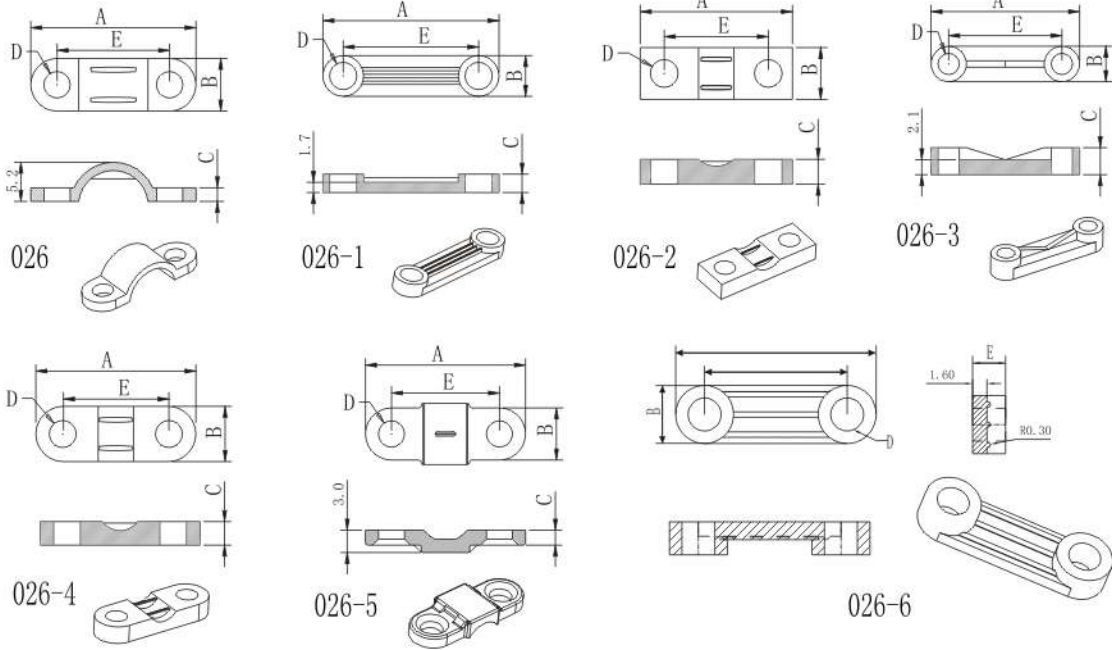

型號 ITEM NO	材質 MATERIAL	尺寸 (DIMENSIONS)					包裝 PACKING	備注 REMARK
		A	B	C	D	E		
026	NYLON66/PC	22	7.1	1.7	∅3.5	15	5000PCS	
026-1	NYLON66/PP	20.5	6.5	3.0	∅3.5	14.5	5000PCS	
026-2	NYLON66/PP	21	7.2	3.5	∅3.8	14.2	5000PCS	
026-3	NYLON66/PP	21	5.0	3.7	∅3.0	16	5000PCS	
026-4	NYLON66/PP	22.6	7.8	3.4	∅3.8	15	5000PCS	
026-5	NYLON66/PC	21.5	7.0	2.0	∅3.5	14.5	5000PCS	
026-6	NYLON66/PC	22.5	6.5	3.7	∅3.7	16	5000PCS	

## 506 地線端子

GROUNDING CONNECTOR

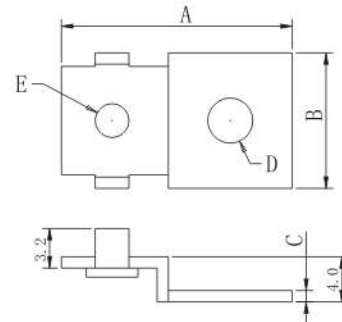

型號 ITEM NO	材質 MATERIAL	尺寸 (DIMENSIONS)					包裝 PACKING	備注 REMARK
		A	B	C	D	E		
506	STEEL	20.5	12	0.8	∅4.0	5/32"牙	5000PCS	5/32" X 4

507 地線端子  
GROUNDING CONNECTOR

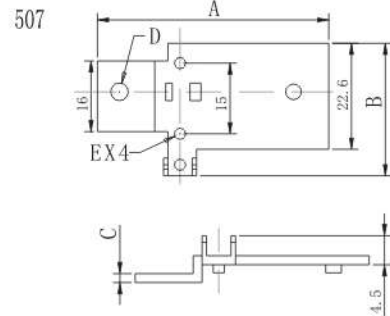

型號 ITEM NO	材質 MATERIAL	尺寸 (DIMENSIONS)					包裝 PACKING	螺絲 SCREW
		A	B	C	D	E		
507	STEEL	53.5	30.2	1.0	∅4.0	1/8"牙	500PCS	1/8" X 3/8" 1/8" X 5.5

040 MR16 燈頭  
ELECTRIC LIGHT SOCKET

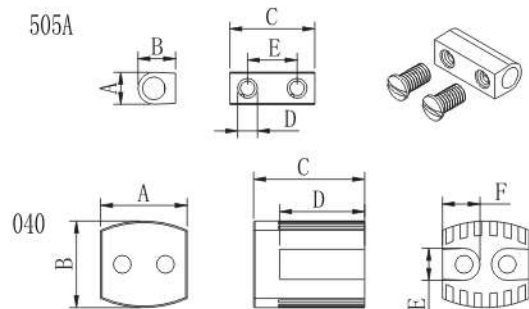

型號 ITEM NO	材質 MATERIAL	尺寸 (DIMENSIONS)						包裝 PACKING	螺絲 SCREW
		A	B	C	D	E	F		
040	NYLON66	12.2	12.3	15.7	12	4.3	5.2	2000PCS	
505A	COPPER	4.3	5.2	12	1/8"牙	7.5		2000PCS	1/8" X 5

505A 505B 505C 五金端子  
BRASS CONNECTOR

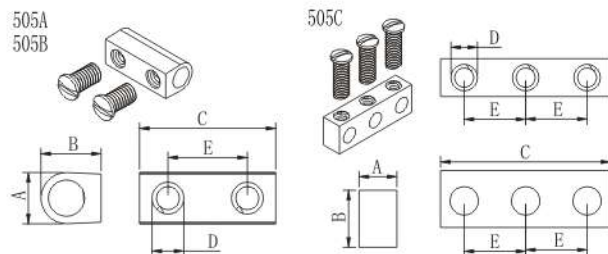

型號 ITEM NO	材質 MATERIAL	尺寸 (DIMENSIONS)					包裝 PACKING	螺絲 SCREW
		A	B	C	D	E		
505A	COPPER	4.3	5.2	12	1/8"牙	7.5	2000PCS	1/8" X 5
505B	COPPER	3.8	4.8	10.2	3/32"牙	6.8	2000PCS	3/32" X 5
505C	COPPER	4.1	6.0	18	1/8"牙	6.7	2000PCS	1/8" X 8

# 墙塞、管塞系列



067 壁虎  
PLUG

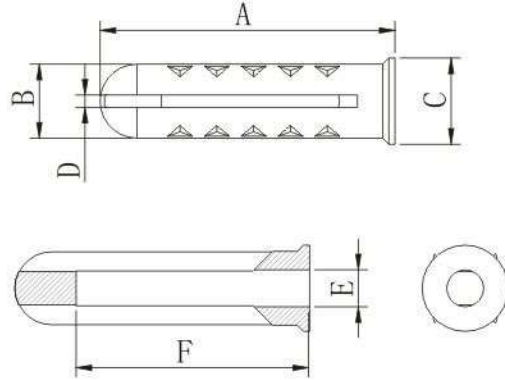

型號 ITEM NO	材質 MATERIAL	尺寸 (DIMENSIONS)						钻头直径 Drill dia	钻孔深度 Hole drill	螺丝尺寸 Screw dia
		A	B	C	D	E	F			
067	PP	24	∅6.0	∅7.0	1.0	∅3.0	19	6	30	3.5~4.2
067-1	PP	24	∅6.0	∅7.0	1.0	∅4.0	19	6	30	3.5~4.2

067A 067D  
067G 壁虎  
PLUG

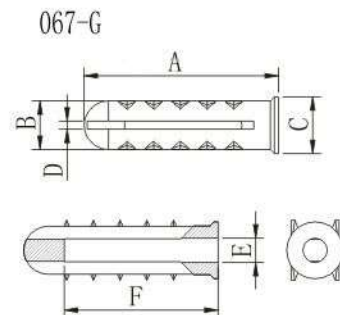
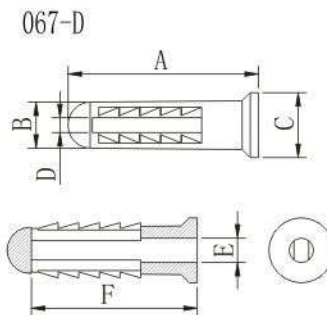
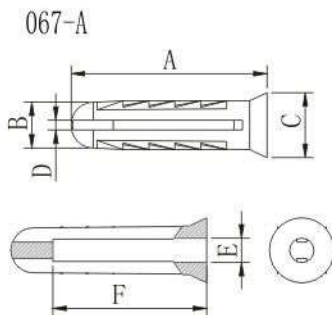

型號 ITEM NO	材質 MATERIAL	尺寸 (DIMENSIONS)						钻头直径 Drill dia	钻孔深度 Hole drill	螺丝尺寸 Screw dia
		A	B	C	D	E	F			
067-A	PP	24.5	∅5.5	∅7.5	1.0	∅3.0	19	6	30	3.5~4.2
067-D	PP	24	∅5.5	∅7.5	1.0	∅3.0	20.5	6	30	3.5~4.2
067-G	PP	28	∅6.0	∅8.0	1.0	∅3.0	25	6	35	3.5~4.2

067/2 壁虎

PLUG

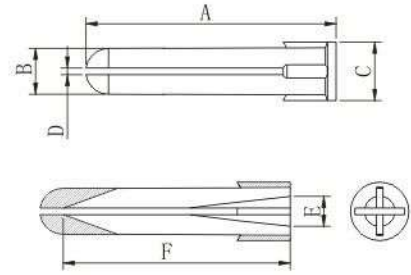

型號 ITEM NO	材質 MATERIAL	尺寸 (DIMENSIONS)						钻头直径 Drill dia	钻孔深度 Hole drill	螺丝尺寸 Screw dia
		A	B	C	D	E	F			
067/2	PP	38	∅7.0	∅8.8	1.2	∅5.0	35	7	45	4.5~5

067B 壁虎

PLUG

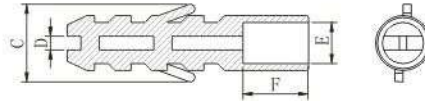
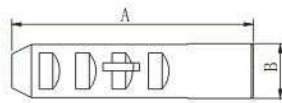

型號 ITEM NO	材質 MATERIAL	尺寸 (DIMENSIONS)						钻头直径 Drill dia	钻孔深度 Hole drill	螺丝尺寸 Screw dia
		A	B	C	D	E	F			
067-B	PP	26.5	∅6	9.0	1.5	∅4.5	7.2	6	30	3.5~4.2

067C 壁虎

PLUG

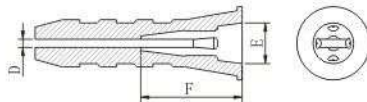
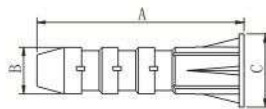

型號 ITEM NO	材質 MATERIAL	尺寸 (DIMENSIONS)						钻头直径 Drill dia	钻孔深度 Hole drill	螺丝尺寸 Screw dia
		A	B	C	D	E	F			
067C	PP	25.5	∅6	∅9.4	0.7	∅5.0	12.5	6	30	3.5~4.2

067F 壁虎

067F-1  
PLUG

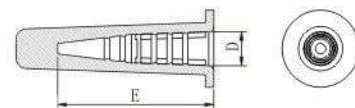
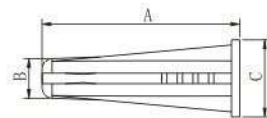

型號 ITEM NO	材質 MATERIAL	尺寸 (DIMENSIONS)					钻头直径 Drill dia	钻孔深度 Hole drill	螺丝尺寸 Screw dia
		A	B	C	D	E			
067F	PP	25.5	∅4.5	∅9.0	∅5.8	23	5	30	2.8~3.2
067F-1	PP	19.2	∅3.8	∅7.4	∅3.2	15	4	25	2~2.6

067J 壁虎  
PLUG

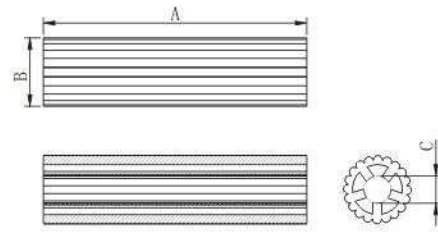

型號 ITEM NO	材質 MATERIAL	尺寸 (DIMENSIONS)			钻头直径 Drill dia	钻孔深度 Hole drill	螺丝尺寸 Screw dia
		A	B	C			
067J	PP	29	∅6.9	∅2.4	7	35	4.5~5

ZG-88 ZG-88A 壁虎  
PLUG

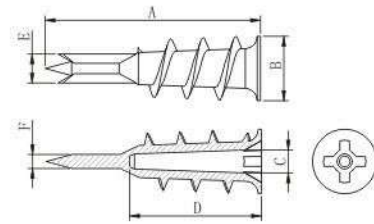
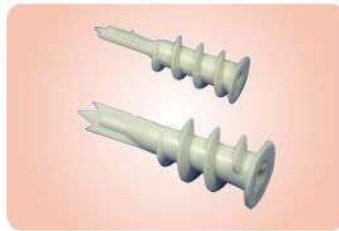

型號 ITEM NO	材質 MATERIAL	尺寸 (DIMENSIONS)						钻头直径 Drill dia	钻孔深度 Hole drill	螺丝尺寸 Screw dia
		A	B	C	D	E	F			
ZG-88	NYLON66	41.5	∅13.3	∅4.2	27	5.9	2.0	14	50	10~11.5
ZG-88A	NYLON66	33.5	∅10	∅3.6	20.5	4.5	1.5	10	40	6~7

ZG-87 弓型壁虎  
PLUG

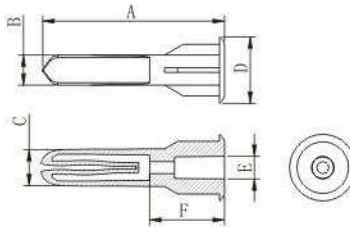

型號 ITEM NO	材質 MATERIAL	尺寸 (DIMENSIONS)						钻头直径 Drill dia	钻孔深度 Hole drill	螺丝尺寸 Screw dia
		A	B	C	D	E	F			
ZG-87	PP	36.5	5.8	7.5	∅13	∅4.5	14	6	40	3.5~4.2

068 壁虎  
PLUG

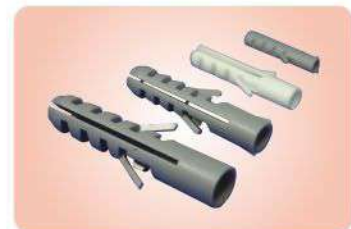
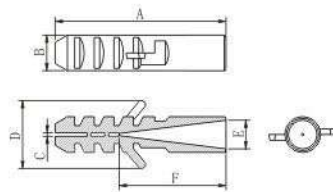

型號 ITEM NO	材質 MATERIAL	尺寸 (DIMENSIONS)						钻头直径 Drill dia	钻孔深度 Hole drill	螺丝尺寸 Screw dia
		A	B	C	D	E	F			
068A	PP	40	∅7.8	1.0	15.0	∅5.8	25	8	50	3.5~4.2
068B	NYLON66	30.5	∅5.5	1.0	12.5	∅4.8	19	6	40	2.8~3.2
068B-S	NYLON66	30.5	∅5.8	1.5	11	∅4.8	9.5	6	40	2.8~3.2
068C	NYLON66	24	∅4.8	1.0	10.0	∅3.8	15	5	30	2~2.6
068D	PP	20	∅4.0	1.0	8.0	∅3.0	11	4	25	1.5~2.2
068E	PP	48	∅9.8	1.0	18	∅8.0	30	10	60	5~5.5

## 110 旋鈕

KNOB

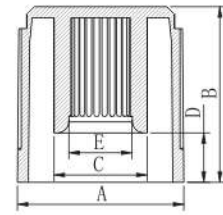

型號 ITEM NO	材質 MATERIAL	尺寸 (DIMENSIONS)					包裝 PACKING	備註 REMARK
		A	B	C	D	E		
110	NYLON66	∅15.2	15.5	∅8.7	4.2	∅6.0	2000PCS	
110A	NYLON66	∅ 13	11.5	∅7.9	5.7	∅5.9	2000PCS	
110B	NYLON66	∅ 13	9	∅7.9	3.2	∅5.9	2000PCS	
110C	NYLON66	∅ 13	7	∅7.9	1.18	∅5.9	2000PCS	
110D	NYLON66	∅ 13	5.8	∅7.9	1.5	∅5.9	2000PCS	

## Z-1 旋鈕



型號 ITEM NO	材質 MATERIAL	尺寸 (DIMENSIONS)					包裝 PACKING	備註 REMARK
		A	B	C	D	E		
Z-1	ABS	∅15	16.1	∅12	4	∅8.5	2000PCS	

## ZG-084 ZG-024GH-S 旋鈕

KNOB

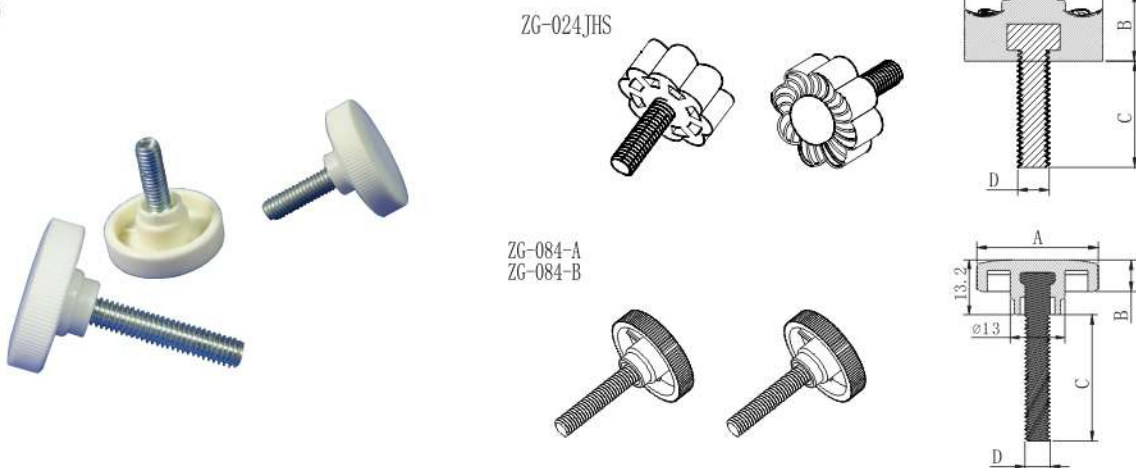

型號 ITEM NO	材質 MATERIAL	尺寸 (DIMENSIONS)				包裝 PACKING	備註 REMARK
		A	B	C	D		
ZG-084A	ABS	∅29	7.5	30	M6	1000PCS	金屬牙
ZG-084B	ABS	∅29	7.5	17	M6	1000PCS	金屬牙
ZG-024JHS	ABS	∅26	13	20	M6	1000PCS	金屬牙

020 020A  
020B 020B-1 牙膏蓋螺母  
CHRYSANTHEMUM NUT

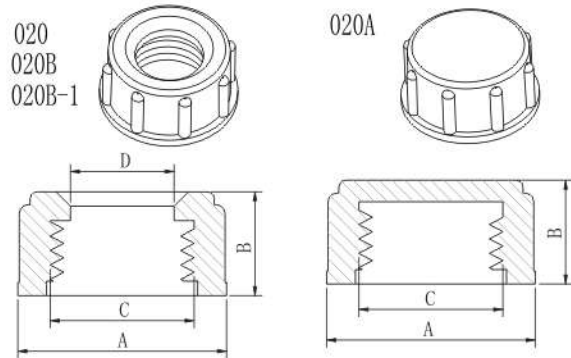

型號 ITEM NO	材質 MATERIAL	尺寸 (DIMENSIONS)				包裝 PACKING	備註 REMARK
		A	B	C	D		
ZG-020	NYLON66	∅14.5	7.5	9.5( $\frac{3}{8}$ " ) 3分27牙	∅7.2	1000PCS	
ZG-020A	NYLON66	∅14.5	7.5	9.5( $\frac{3}{8}$ " ) 3分27牙		1000PCS	未通孔
ZG-020B	NYLON66	∅18	7.7	12.7( $\frac{1}{2}$ " ) 4分18牙	∅8.6	1000PCS	
ZG-020B-1	NYLON66	∅18	7.7	12.7( $\frac{1}{2}$ " ) 4分20牙	∅8.6	1000PCS	

024GH 菊花螺母  
CHRYSANTHEMUM NUT

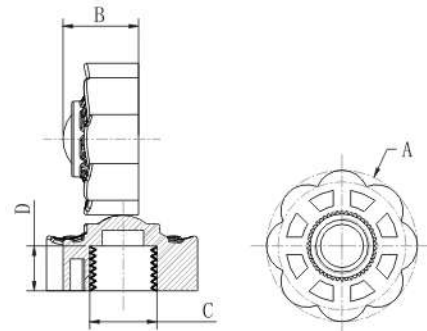

型號 ITEM NO	材質 MATERIAL	尺寸 (DIMENSIONS)				包裝 PACKING	備註 REMARK
		A	B	C	D		
024JH	NYLON66	∅26	13	M10	7.5	1000PCS	金屬牙
024JH-1	NYLON66	∅26	13	M4	7.5	1000PCS	金屬牙

024 024A  
024SW 菊花螺母  
CHRYSANTHEMUM NUT

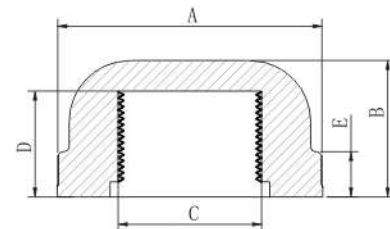

型號 ITEM NO	材質 MATERIAL	尺寸 (DIMENSIONS)					包裝 PACKING	備註 REMARK
		A	B	C	D	E		
ZG-024	PP	∅18	9.2	9.5( $\frac{3}{8}$ " ) 3分27牙	7.2	3.0	1000PCS	
ZG-024A	PP	∅17.2	12.2	9.5( $\frac{3}{8}$ " ) 3分27牙	9.8	7.0	1000PCS	
ZG-024SW	PP	∅18	10	9.5( $\frac{3}{8}$ " ) 3分27牙	6.0	5.2	1000PCS	金屬牙

### 管外塞 (小)

TUBE SHELTERS SUIT

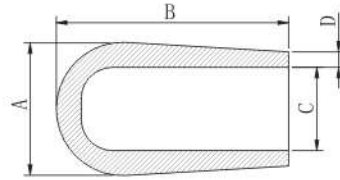

型號 ITEM NO	材質 MATERIAL	尺寸 (DIMENSIONS)				包裝 PACKING	備注 REMARK
		A	B	C	D		
101 3mm	PVC	∅5.6	11.5	∅3.0	0.5	2000PCS	
101 4mm	PVC	∅6.5	11.5	∅4.0	1.0	2000PCS	
101 5mm	PVC	∅7.0	13.5	∅5.0	0.75	2000PCS	
101 6mm	PVC	∅8.0	15.0	∅6.0	1.0	2000PCS	
101 7mm	PVC	∅10.9	14.5	∅7.0	1.75	2000PCS	
101 8mm	PVC	∅11	14.5	∅8.0	1.35	2000PCS	

### 管外塞 (大)

TUBE SHELTERS SUIT

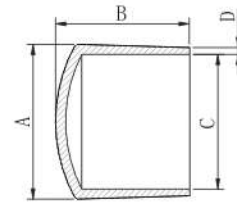

型號 ITEM NO	材質 MATERIAL	尺寸 (DIMENSIONS)				包裝 PACKING	備注 REMARK
		A	B	C	D		
101 1 1/2"	PVC	∅11.8	13	∅9.5 (3/8") 3分	0.9	2000PCS	
101 1 3/4"	PVC	∅15	13.8	∅12.7 (1/2") 4分	1.0	2000PCS	
101 2"	PVC	∅18.5	16.9	∅15.9 (5/8") 5分	1.0	2000PCS	
101 2 1/4"	PVC	∅21.6	19.5	∅19.1 (3/4") 6分	1.1	2000PCS	
101 2 1/2"	PVC	∅26	21.8	∅22.2 (7/8") 7分	1.3	2000PCS	
101 1"	PVC	∅28.5	23.2	∅25.4 (1") 1寸	1.3	2000PCS	
101 1 1/4"	PVC	∅35	25.4	∅31.8 (1 1/4") 1寸4分	1.5	2000PCS	
101 1 1/2"	PVC	∅42	26	∅40 (1 1/2") 1寸2分	2.0	2000PCS	

### TEE 高爾夫球頂

GOIF TEE

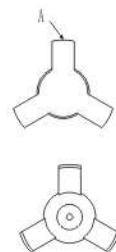
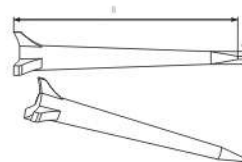
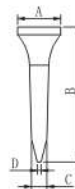

型號 ITEM NO	材質 MATERIAL	尺寸 (DIMENSIONS)				包裝 PACKING	備注 REMARK
		A	B	C	D		
TEE-69	PP	∅11.1	69	∅4.0	∅1.0	2000PCS	
TEE-59	PP	∅11	59	∅4.3	∅1.0	2000PCS	
TEE-40	PP	∅11	40	∅4.0	∅1.0	2000PCS	
TEE-84	PP	∅10.9	84	∅4.0	∅1.2	2000PCS	
TEE-74	PP	∅16.5	71	∅4.0	∅1.0	2000PCS	三角頭
TEE-72	PP	∅16	77	∅5.0	∅11.5	2000PCS	三角頭

### 管外塞 (開口型)

#### TUBE SHELTERS SUIT

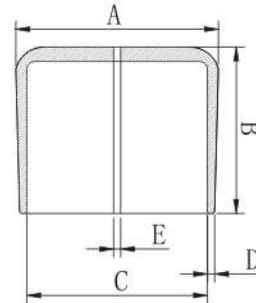

型號 ITEM NO	材質 MATERIAL	尺寸 (DIMENSIONS)					包裝 PACKING	備注 REMARK
		A	B	C	D	E		
101 1/OP	PVC	ø28.5	22.5	ø25.4	1.0	1.2	1000PCS	

### 扣式塞頭

#### HOLE PLUG

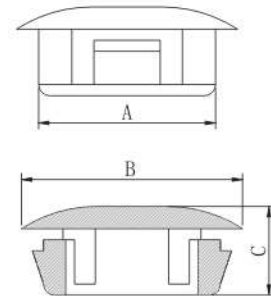

型號 ITEM NO	材質 MATERIAL	尺寸 (DIMENSIONS)			包裝 PACKING	備注 REMARK
		A 鐵板孔径	B 覆蓋外径	C 高度		
B09 (019)	NYLON66	ø9.5	ø21	10.2	1000PCS	
HP-5	NYLON66	ø4.5	ø6.3	5.9	1000PCS	
HP-8A	NYLON66	ø8.0	ø9.9	4.0	1000PCS	
HP-8	NYLON66	ø7.8	ø11.9	8.0	100PCS	
HP-10	NYLON66	ø9.5	ø13.0	10.5	100PCS	
HP-13	NYLON66	ø12.7	ø16.9	10.5	100PCS	
HP-13S	NYLON66	ø12.7	ø14.5	10.1	1000PCS	
HP-15	NYLON66	ø14.3	ø16.7	10.3	1000PCS	
HP-16	NYLON66	ø15.9	ø19.8	10.5	100PCS	
HP-19	NYLON66	ø19.0	ø22.9	10.5	100PCS	
HP-22	NYLON66	ø22.2	ø24.9	11.3	100PCS	
HP-25	NYLON66	ø25.0	ø28.3	11.5	100PCS	
HP-30	NYLON66	ø30.0	ø34.2	11.5	100PCS	
HP-38	NYLON66	ø38.1	ø42.4	11.2	100PCS	
HP-45	NYLON66	ø44.5	ø49.1	11.1	100PCS	

## 方型塞頭

### RECTANGLE PLUG

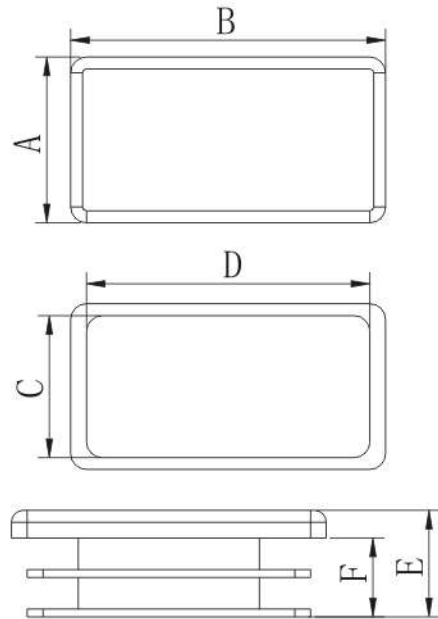

型號 ITEM NO	材質 MATERIAL	尺寸 (DIMENSIONS)						包裝 PACKING	備注 REMARK
		A	B	C	D	E	F		
H2550	PP	25	50	23.5	48	18.7	15.2	500PCS	
H2525	PP	25	25	24	24	13.2	9.9	500PCS	
H2222	PP	22	22	21	21	17.5	14.7	500PCS	
H2040	PP	20	40	19	38	13.5	10	500PCS	
H2020	PP	20	20	19.3	19.3	11.1	8.6	1000PCS	
H1818	PP	18	18	17	17	13	10.5	1000PCS	
H1616	PP	16	16	14.8	14.8	12.3	9.8	1000PCS	
H1530	PP	15	30	13.5	28.5	13.8	11.3	1000PCS	
H1313	PP	13	13	12	11.1	12.1	9.4	1000PCS	
H1020	PP	10	20	9.0	18.8	10.6	8	1000PCS	
H1326	PP	13	26	12	25	12.5	10.1	1000PCS	
H3232	PP	32	32	30.8	30.8	19.5	15.3	400PCS	
H3838	PP	38	38	36.8	36.7	14.7	12.2	300PCS	
H3060	PP	30	60	28.4	58.2	14.3	11.3	200PCS	

## 圓型管塞（薄）

CIRCULAR PLUG

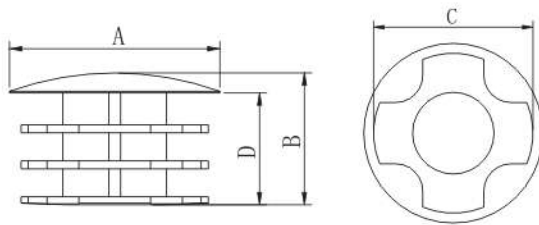

型號 ITEM NO	材質 MATERIAL	尺寸 (DIMENSIONS)				包裝 PACKING	備註 REMARK
		A 覆蓋外径	B 高度	C	D		
102 1½"	PP	ø38.1 (1寸4分)	18	ø36.5	14	500PCS	
102 1⅜"	PP	ø34.9 (1寸3分)	18.5	ø33.5	16	500PCS	
102 1¼"	PP	ø31.7 (1寸2分)	16.5	ø30.5	13.5	500PCS	
102 1"	PP	ø25.4 (1寸)	16.5	ø24.5	14	1000PCS	
102 ⅞"	PP	ø22.2 (7分)	12	ø21	9.5	1000PCS	
102 ¾"	PP	ø19 (6分)	11.5	ø18.3	9.0	1000PCS	
102 ⅝"	PP	ø15.8 (5分)	11	ø15	8.5	1000PCS	
102 ½"	PP	ø12.7 (4分)	11	ø12	8.5	1000PCS	
102 ⅜"	PP	ø9.5 (3分)	9	ø8.5	7.0	1000PCS	

## 圓型管塞（厚）

CIRCULAR PLUG

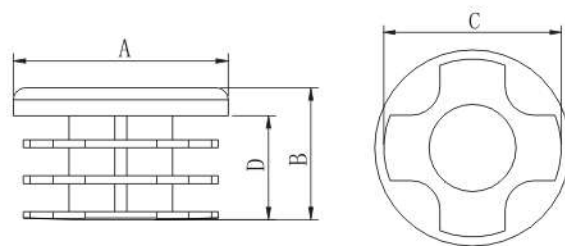

型號 ITEM NO	材質 MATERIAL	尺寸 (DIMENSIONS)				包裝 PACKING	備註 REMARK
		A 覆蓋外径	B 高度	C	D		
103 1¼"	NYLON66	ø31.5 (1寸2分)	17.7	ø30.7	14	500PCS	
103 1⅜"	NYLON66	ø28.3 (1寸1分)	16.7	ø27.4	13.7	500PCS	
103 1"	NYLON66	ø25.4 (1寸)	16.7	ø24.5	13.2	500PCS	
103 ⅞"	NYLON66	ø22.2 (7分)	12	ø21.0	9.3	1000PCS	
103 ¾"	NYLON66	ø19.1 (6分)	12	ø18.1	9.2	1000PCS	
103 ⅝"	NYLON66	ø15.9 (5分)	11.5	ø15.1	9.0	1000PCS	
103 ½"	NYLON66	ø12.7 (4分)	11.1	ø12	9.0	1000PCS	

# 玻璃、端子、綫帽、綫扣、端子臺

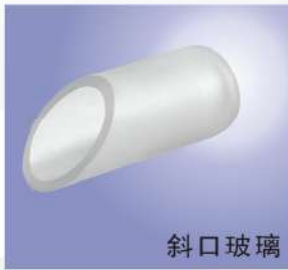

斜口玻璃

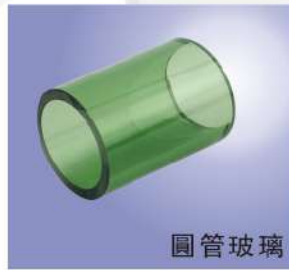

圓管玻璃

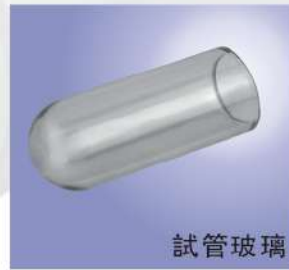

試管玻璃



斗笠玻璃罩

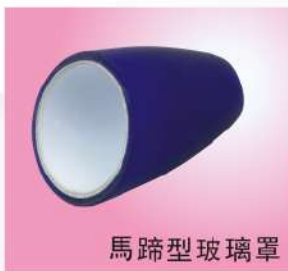

馬蹄型玻璃罩



碟型玻璃

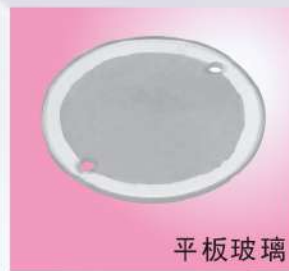

平板玻璃



烤彎玻璃

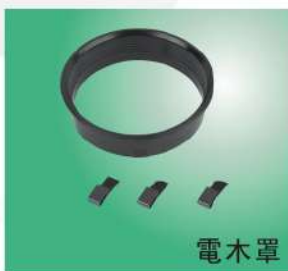

電木罩



玻璃夾片



玻璃夾片



玻璃夾片



電源綫扣

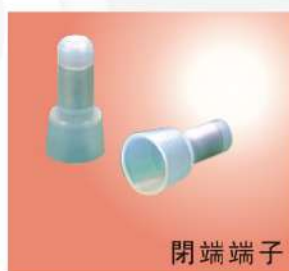

閉端端子



PA10B



PA11



電路板端子臺



PUSH-IN



接綫帽



端子臺

### 圓管玻璃

CIRCULAR TUBE GLASS

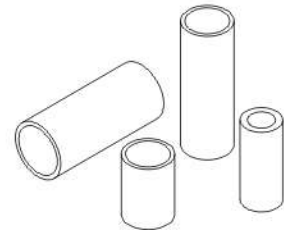
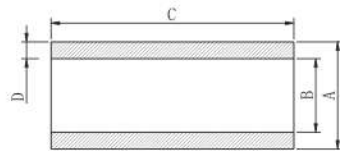

### 碟型玻璃罩

SMALL PLATE FORM GLASS SHADE

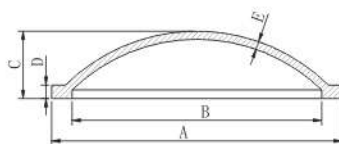

### 試管玻璃

TEST TUBE GLASS

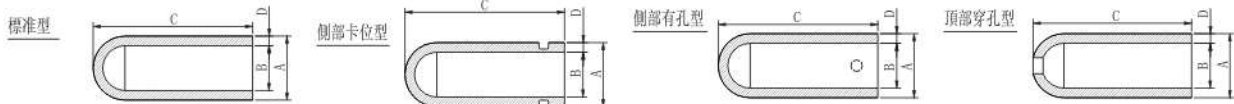

### 門笠玻璃罩(大、中)

BAMBOO HAT GLASS

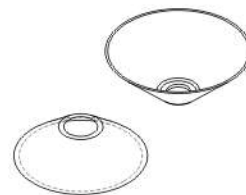
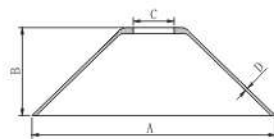

### 門笠玻璃罩(小)

BAMBOO HAT GLASS

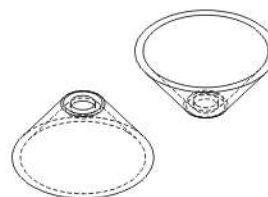
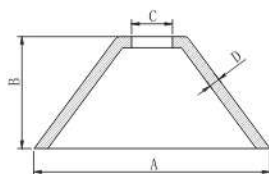

注：玻璃產品可依客戶規格、尺寸、紋理等要求制作。

Note : The glass goods may be according to client's standard, Dimensions, That the grain awaint requires manufacturing.

### 防爆玻璃

EXPLOSION PROOF GLASS

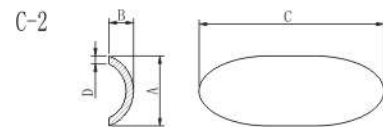
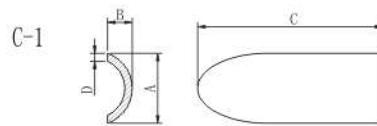
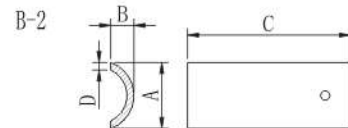
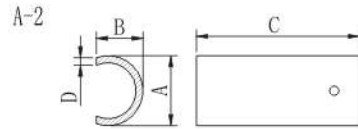
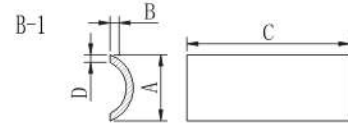
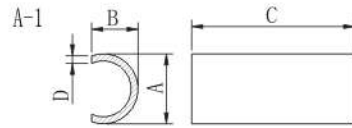
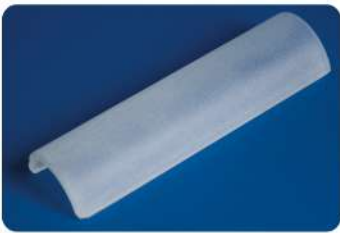

### 平板玻璃

FLAT PLATE GLASS

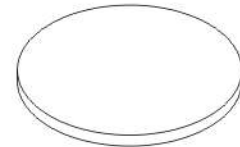
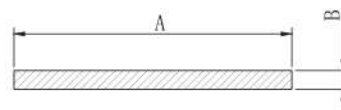

### 斜口玻璃

SLANTING RIM GLASS

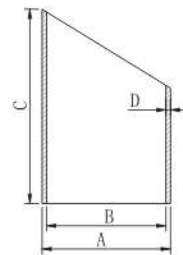
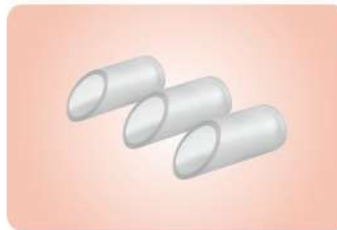

### 馬蹄型玻璃罩

HOOF FORM GLASS

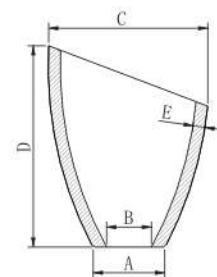

注：玻璃產品可依客戶規格、尺寸、紋理等要求制作。

Note : The glass goods may be according to client's standard, Dimensions, That the grain await requires manufacturing.

### 511 玻璃夾片

GLASS SPRING

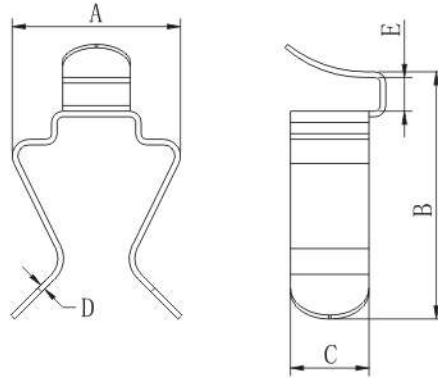

型號 ITEM NO	材質 MATERIAL	尺寸 (DIMENSIONS)					包裝 PACKING	備注 REMARK
		A	B	C	D	E		
511	STEEL SPRING	18	26	7.0	0.4	3.0	500PCS	

### 512 玻璃夾片

GLASS SPRING

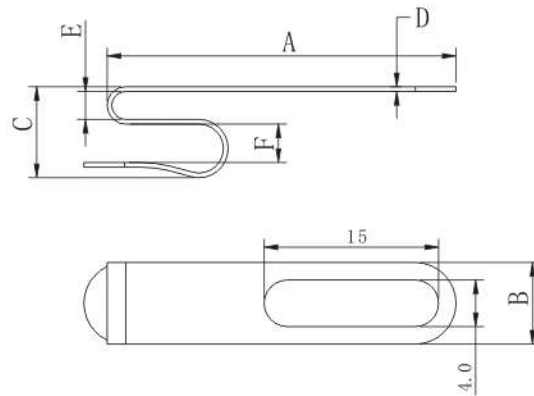

型號 ITEM NO	材質 MATERIAL	尺寸 (DIMENSIONS)						包裝 PACKING	備注 REMARK
		A	B	C	D	E	F		
512	STEEL SPRING	30	7.0	7.0	0.4	2.5	2.6	2000PCS	

### 512B 玻璃夾片

GLASS SPRING

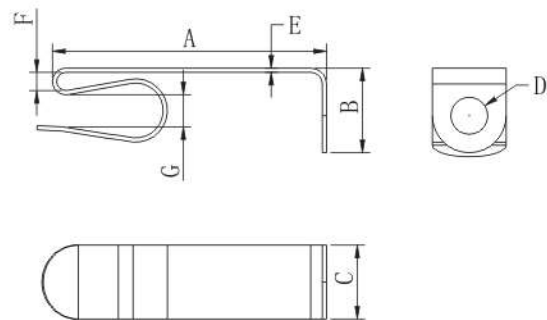

型號 ITEM NO	材質 MATERIAL	尺寸 (DIMENSIONS)							包裝 PACKING	備注 REMARK
		A	B	C	D	E	F	G		
512B	STEEL SPRING	27.5	7.9	7.0	∅3.2	0.5	2.8	3.0	2000PCS	

### 513 玻璃夾片

GLASS SPRING

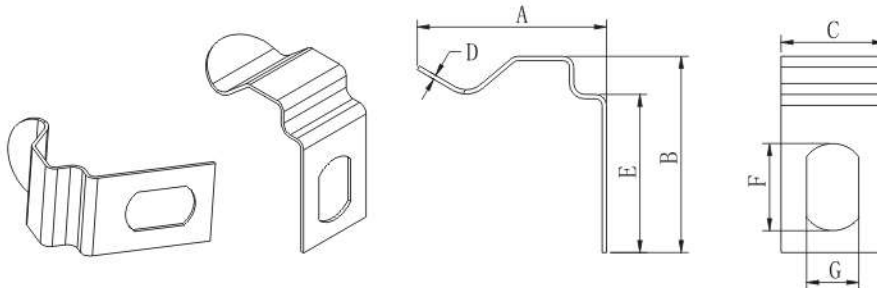

型號 ITEM NO	材質 MATERIAL	尺寸 (DIMENSIONS)							包裝 PACKING	備注 REMARK
		A	B	C	D	E	F	G		
513	STEEL / SPRING	17.5	18	9.5	0.5	14	8.0	4.7	2000PCS	

### 電木罩

BAKELITE HOOP

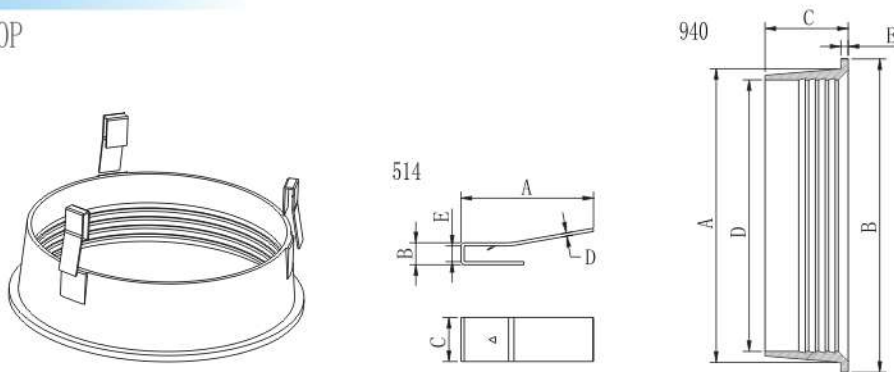

型號 ITEM NO	材質 MATERIAL	尺寸 (DIMENSIONS)					包裝 PACKING	備注 REMARK
		A	B	C	D	E		
940	BAKELITE	∅88	∅94	28	∅81.5	2.2	50PCS	
514	STEEL SPRING	21	3.9	7.0	0.4	3.0	2000PCS	

### 515 玻璃夾片

GLASS SPRING

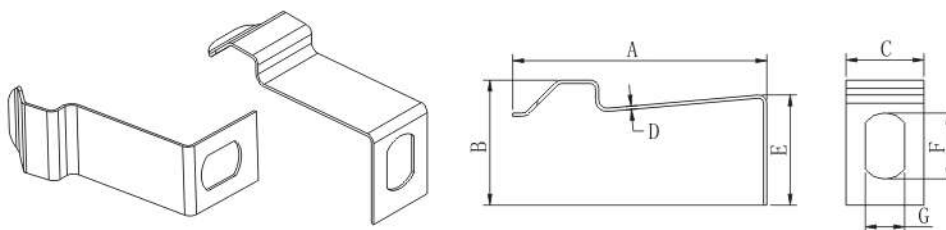

型號 ITEM NO	材質 MATERIAL	尺寸 (DIMENSIONS)							包裝 PACKING	備注 REMARK
		A	B	C	D	E	F	G		
515	STEEL SPRING	31	17	9.5	0.5	13	7.9	4.8	2000PCS	

## 端子臺(H型)

### Terminal Block (H Type)

底座：底座加高1.0-1.2mm

膠殼：尼龍66工程塑料，UL94V-2、94V-0等阻燃等級

溫度：105°C(UL)，-30°C to T110°C(IEC)

線座：銅合金，鍍鎳

彈片：不銹鋼材質，230WP/PA8DS、500WP/PA10DS附加彈片

螺絲：碳鋼螺絲，鍍鋅

剝線長度：230/PA8約5.0mm(公裏)/0.20in.(寸);

500/PA10約6.5mm(公裏)/0.26in.(寸);

接線排數：1-12排

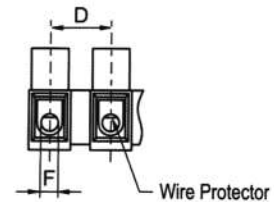
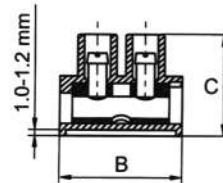
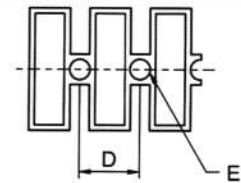
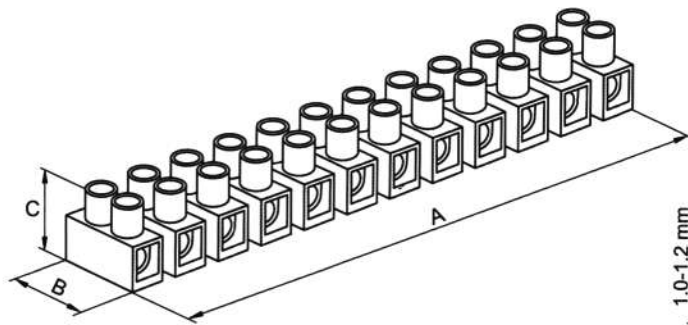
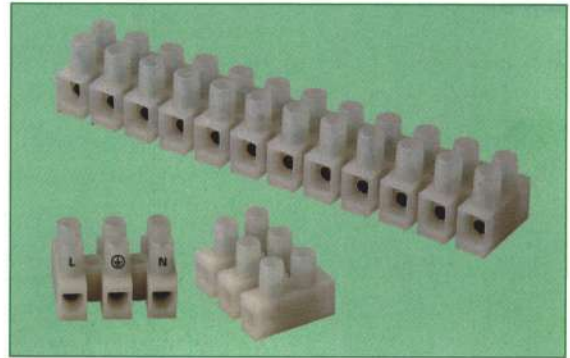

#### 規格尺寸(Dimensions):

型號 ITEM NO	訂單編號 Cat. NO.	安培 Amp	適用電線/Wire Range		螺絲 Screw	尺寸Dimensions(mm)						包裝單位 Packing
			Cross-Sec.	(Cu, AWG)		A	B	C	D	E	F	
230	230	17.5	1.5mm <sup>2</sup>	22-12 Sol/Str	M2.6X5	93.50	17.70	15.50	8.00	2.90	2.8±0.1	50Pcs/Bag 500Pcs/Ctn
230WP	230WP	17.5	1.5mm <sup>2</sup>	22-12 Sol/Str	M2.6X5	93.50	17.70	15.50	8.00	2.90	2.8±0.1	50Pcs/Bag 500Pcs/Ctn
PA8	PA8H	17.5	1.5mm <sup>2</sup>	22-12 Sol/Str	M2.6X5	96.20	17.00	14.50	8.00	2.90	2.8±0.1	50Pcs/Bag 500Pcs/Ctn
PA8DS	PA8HDS	17.5	1.5mm <sup>2</sup>	22-12 Sol/Str	M2.6X5	96.20	17.00	14.50	8.00	2.90	2.8±0.1	50Pcs/Bag 500Pcs/Ctn
500	500	24	2.5mm <sup>2</sup>	22-10 Sol 14-10 Str	M3.0X6	116.5	16.50	16.50	10.00	3.60	3.4±0.1	50Pcs/Bag 500Pcs/Ctn
500WPS	500WP	24	2.5mm <sup>2</sup>	22-10 Sol 14-10 Str	M3.0X6	116.5	16.50	16.50	10.00	3.60	3.4±0.1	50Pcs/Bag 500Pcs/Ctn
PA10	PA10H	24	2.5mm <sup>2</sup>	22-10 Sol 14-10 Str	M3.0X6	116.5	20.20	16.80	10.00	3.60	3.4±0.1	50Pcs/Bag 500Pcs/Ctn
PA10DS	PA10HDS	24	2.5mm <sup>2</sup>	22-10 Sol 14-12 Str	M3.0X6	116.5	20.20	16.80	10.00	3.60	3.4±0.1	50Pcs/Bag 500Pcs/Ctn
502	502	24	1.5-4.0mm <sup>2</sup>	22-10 Sol 14-12 Str	M3.0X6	116.5	30.50	21.50	10.00	3.60	3.4±0.1	50Pcs/Bag 500Pcs/Ctn

## 端子臺(H型)

### Terminal Block (H Type)

底座：底座加高1.2-2.5mm

膠殼：尼龍66工程塑料，UL94V-2、94V-0等阻燃等級

溫度：105°C(UL)，-30°C to T110°C(IEC)

線座：銅合金，鍍銀

彈片：不銹鋼材質，830WP/PA12DS、PA14DS附加彈片

螺絲：碳鋼絲，鍍鋅

剝線長度：830/PA12約7.0mm(公裏)/0.28in.(寸)；

PA14約9.0mm(公裏)/0.35in.(寸)；

接線排數：1-12排

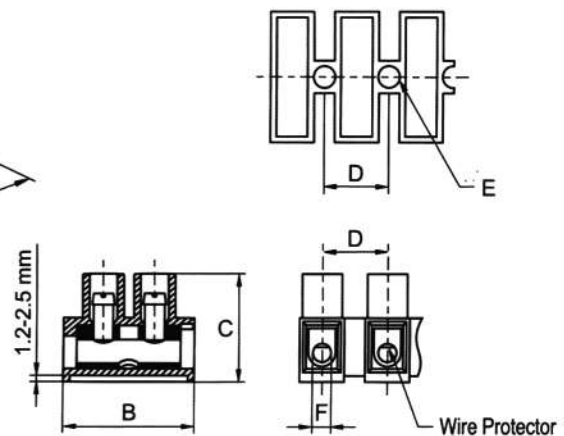
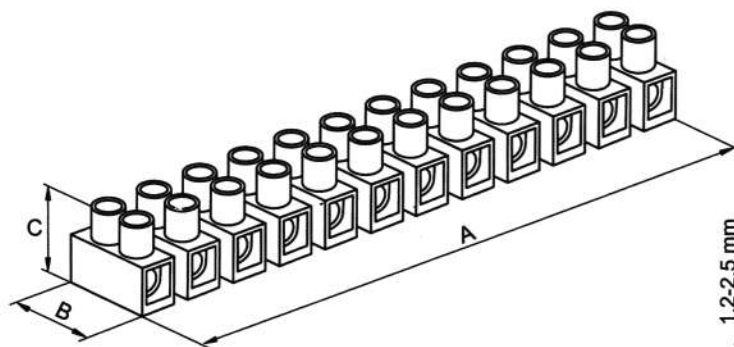

型號 ITEM NO	訂單編號 Cat. NO.	安培 Amp	適用電線/Wire Range		螺絲 Screw	尺寸Dimensions(mm)						包裝單位 Packing
			Cross-Sec.	(Cu, AWG)		A	B	C	D	E	F	
830	830	41.0	6.0mm <sup>2</sup>	22-10 Sol/Str	M3.5x7	139.5	23.80	19.50	12.00	3.90	4.2±0.1	40Pcs/Bag 400Pcs/Ctn
830WP	830WP	41.0	6.0mm <sup>2</sup>	22-10 Sol/Str	M3.5x7	139.5	23.80	19.50	12.00	3.90	4.2±0.1	40Pcs/Bag 400Pcs/Ctn
PA12	PA12H	41.0	6.0mm <sup>2</sup>	22-10 Sol/Str	M3.5x7	141.0	23.80	19.00	12.00	3.90	4.2±0.1	25Pcs/Bag 250Pcs/Ctn
PA12DS	PA12HDS	41.0	6.0mm <sup>2</sup>	22-10 Sol/Str	M3.5x7	141.0	23.80	19.00	12.00	3.90	4.2±0.1	25Pcs/Bag 250Pcs/Ctn
PA14	PA14H	57.0	10.0mm <sup>2</sup>	20-8 Sol/Str	M4.0x9	158.0	25.60	25.20	13.50	4.40	5.0±0.1	25Pcs/Bag 250Pcs/Ctn
PA14DS	PA14HDS	57.0	10.0mm <sup>2</sup>	20-8 Sol/Str	M4.0x9	158.0	25.60	25.20	13.50	4.40	5.0±0.1	25Pcs/Bag 250Pcs/Ctn

## 印刷电路板型端子臺

PCB Terminal Block (With Horizontal Solder Pin)

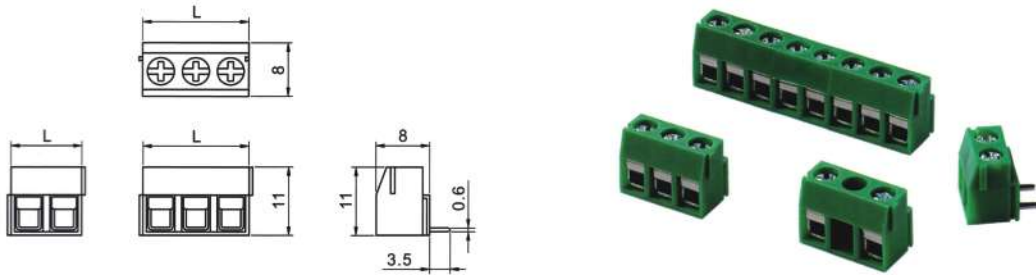

型號 ITEM NO	訂單編號 Cat. NO.	極數 Poles	電氣規格與適用電綫 Ratings & Wire Range	針腳間距 Pin Spacing	L長度 L Length
PA002	PA002-2P	2	IEC: 17.5A, 250V, T110 (230°F) 0.5-1.5mm <sup>2</sup> UL: 10A, 300V, 75°C (167°F) #26-#14 AWG, Cu	5 mm	10 mm
	PA002-3P	3	IEC: 17.5A, 250V, T110 (230°F) 0.5-1.5mm <sup>2</sup> UL: 10A, 300V, 75°C (167°F) #26-#14 AWG, Cu	5 mm	15 mm



## 印刷电路板型端子臺

PCB Terminal Block (With Vertical Solder Pin)

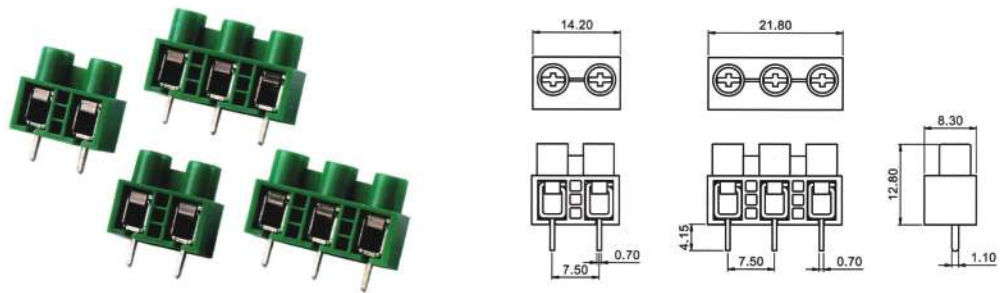

型號 ITEM NO	訂單編號 Cat. NO.	極數 Poles	電氣規格與適用電綫 Ratings & Wire Range	針腳間距 Pin Spacing	L長度 L Length
PA007	PA007-2P	2	IEC: 24A, 400 V, T120 (167°F) 0.5-2.5mm <sup>2</sup> UL: 15A, 300V, 75°C (167°F) #18-#14 AWG, Cu	7.5 mm	14.2 mm
	PA007-3P	3	IEC: 24A, 400 V, T120 (167°F) 0.5-1.5mm <sup>2</sup> UL: 15A, 300V, 75°C (167°F) #18-#14 AWG, Cu	7.5 mm	14.2 mm



## 印刷電路板型端子臺

### PCB Terminal Block (With Vertical Solder Pin)

PA 66工程塑料外殼，UL 94V-0 阻燃等級。

工作溫度105℃(UL)，-25℃ to T120(IEC)。

鍍錫銅合金，方形接線孔接線端子。

附不銹鋼擋片。

模組化設計。

剥綫後插入端子內，鎖上螺絲即可。

適用於消費性或商業性電子產品。

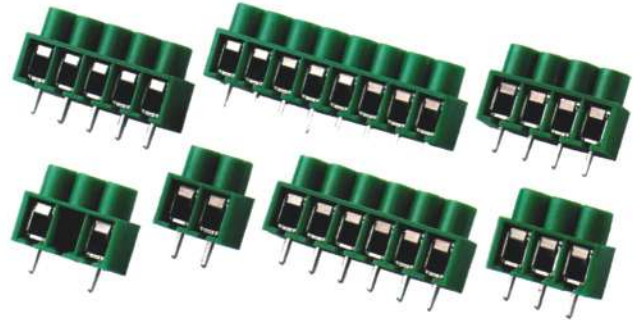

型號 ITEM NO	訂單編號 Cat. NO.	極數 Poles	電氣規格與適用電綫 Ratings & Wire Range	針腳間距 Pin Spacing	L長度 L Length
PA003	PA003-2P	2	IEC: 24A, 400 V, T120 (248°F) 0.5-2.5mm <sup>2</sup> UL: 15A, 300V, 75°C (167°F) #18-#14 AWG, Cu	5 mm	11.5 mm
	PA003-3P	3	IEC: 24A, 400 V, T120 (248°F) 0.5-2.5mm <sup>2</sup> UL: 15A, 300V, 75°C (167°F) #18-#14 AWG, Cu	5 mm	16.5 mm
	PA003-4P	4	IEC: 24A, 400 V, T120 (248°F) 0.5-2.5mm <sup>2</sup> UL: 15A, 300V, 75°C (167°F) #18-#14 AWG, Cu	5 mm	21.5 mm
	PA003-5P	5	IEC: 24A, 400 V, T120 (248°F) 0.5-2.5mm <sup>2</sup> UL: 15A, 300V, 75°C (167°F) #18-#14 AWG, Cu	5 mm	26.5 mm
	PA003-6P	6	IEC: 24A, 400 V, T120 (248°F) 0.5-2.5mm <sup>2</sup> UL: 15A, 300V, 75°C (167°F) #18-#14 AWG, Cu	5 mm	31.5 mm
	PA003-8P	8	IEC: 24A, 400 V, T120 (248°F) 0.5-2.5mm <sup>2</sup> UL: 15A, 300V, 75°C (167°F) #18-#14 AWG, Cu	5 mm	41.5 mm

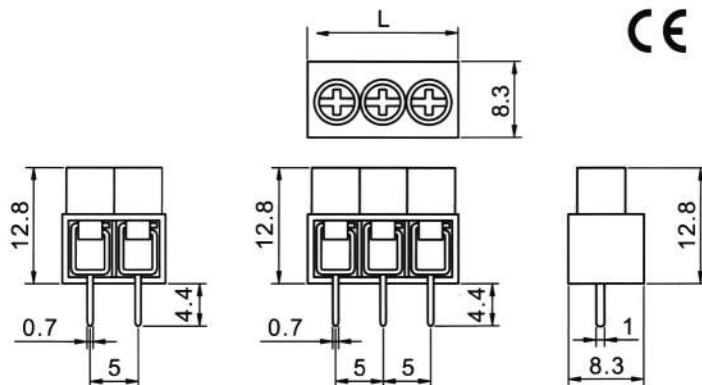

## 彈簧式印刷電路板型端子臺

### PCB Spring Terminal Block (With Vertical Solder Pin)

PA 66工程塑料外殼，UL 94V-0 阻燃等級。  
 工作溫度115°C(UL)，-20°C to T105(IEC)。  
 鍍錫銅合金，不銹鋼彈片接線端子。  
 模組化設計，可依需要組裝連結端子數。  
 按壓鍵可以簡化導線的接線操作。  
 手動或使用螺絲刀按下推壓鍵，把裸線插入端子內，  
 放開推壓鍵即可。  
 適用於各種電子設備中的印刷電路板。

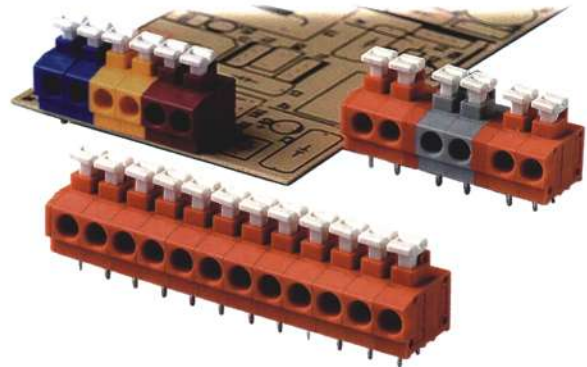

型號 ITEM NO	訂單編號 Cat. NO.	針腳類別 Pitch Type	電氣規格與適用電線 Ratings & Wire Range	針腳間距 Pin Spacing
235	235-1	1	IEC: 24A, 250 V, T105 (221°F) 0.5-2.5mm <sup>2</sup> UL: 10A, 300V, 115°C (239°F) #20-#14 AWG, Cu	5.0 mm
	235-2	2	IEC: 24A, 450 V, T105 (221°F) 0.5-2.5mm <sup>2</sup> UL: 10A, 300V, 115°C (239°F) #20-#14 AWG, Cu	7.5 mm
	235-3	3	IEC: 24A, 500 V, T105 (221°F) 0.5-2.5mm <sup>2</sup> UL: 10A, 300V, 115°C (239°F) #20-#14 AWG, Cu	10.0 mm

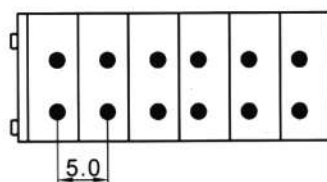
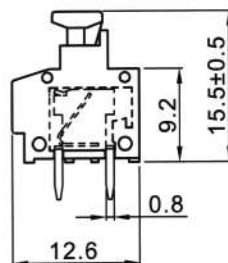
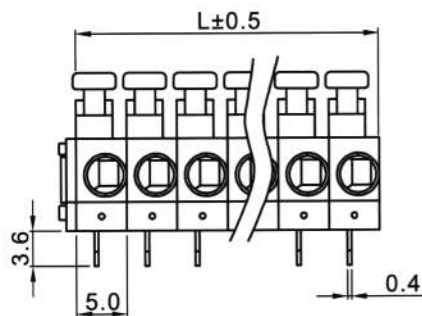

Pitch Type 1

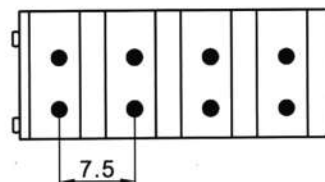

Pitch Type 2

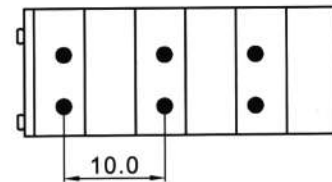

Pitch Type 3

## 彈簧式印刷電路板型端子臺

### PCB Spring Terminal Block (With Vertical Solder Pin)

PA 66工程塑料外殼，UL 94V-0 阻燃等級。  
 工作溫度115°C(UL)，-20°C to T105(IEC)。  
 鍍錫銅合金，不銹鋼彈片接線端子。  
 模組化設計，可依需要組裝連結端子數。  
 按壓鍵可以簡化導線的接線操作。  
 手動或使用螺絲刀按下推壓鍵，把裸線插入端子內，  
 放開推壓鍵即可。  
 適用於各種電子設備中的印刷電路板。



型號 ITEM NO	訂單編號 Cat. NO.	針腳類別 Pitch Type	電氣規格與適用電線 Ratings & Wire Range	針腳間距 Pin Spacing
250	250-1	1	IEC: 17.5A, 500 V, T105 (221° F) 0.5-2.5mm <sup>2</sup> UL: 5A, 300V, 115°C (239° F) #20-#16 AWG, Cu	3.5 mm
	250-2	2	IEC: 17.5A, 500 V, T105 (221° F) 0.5-2.5mm <sup>2</sup> UL: 5A, 300V, 115°C (239° F) #20-#16 AWG, Cu	7.0mm

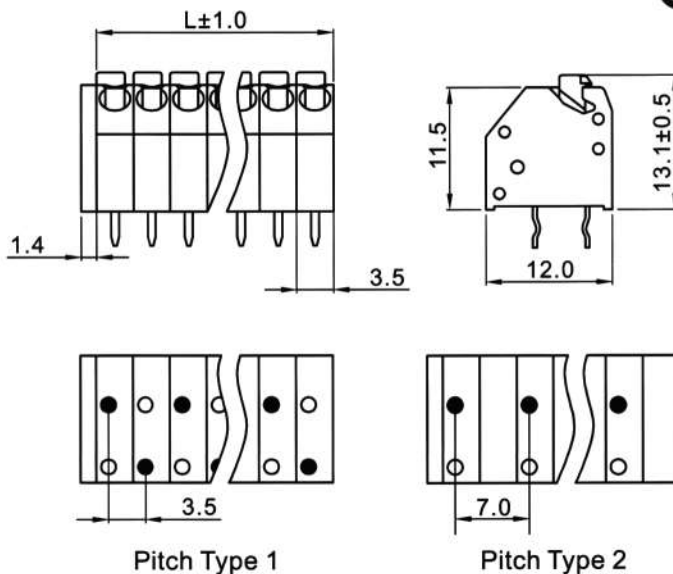

## 印刷電路板型端子臺

### PCB Terminal Block (With Vertical Solder Pin)

PA 66工程塑料外殼, UL 94V-0 阻燃等級。

工作溫度105°C(UL), -25°C to T110(IEC)。

鍍錫銅合金, 方形接線孔接線端子。

附不銹鋼擋片。

模組化設計, 可依需要組裝連結端子數。

剥綫後插入端子內, 鎖上螺絲即可。

適用於消費性或商業性電子產品。

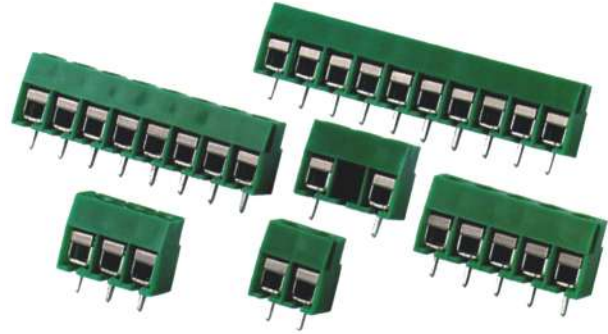

型號 ITEM NO	訂單編號 Cat. NO.	極數 Poles	電氣規格與適用電綫 Ratings & Wire Range	針腳類別 Pitch Type	L長度 L Length
PA001	PA001-2P	2	IEC: 17.5A, 250 V, T110 (230°F) 0.5-1.5mm <sup>2</sup> UL: 10A, 300V, 75°C (167°F) #26-#14 AWG, Cu	5mm	10mm
	PA001-3P	3	IEC: 17.5A, 250 V, T110 (230°F) 0.5-1.5mm <sup>2</sup> UL: 10A, 300V, 75°C (167°F) #26-#14 AWG, Cu	5mm	15mm
	PA001-4P	4	IEC: 17.5A, 250 V, T110 (230°F) 0.5-1.5mm <sup>2</sup> UL: 10A, 300V, 75°C (167°F) #26-#14 AWG, Cu	5mm	20mm
	PA001-5P	5	IEC: 17.5A, 250 V, T110 (230°F) 0.5-1.5mm <sup>2</sup> UL: 10A, 300V, 75°C (167°F) #26-#14 AWG, Cu	5mm	25mm
	PA001-6P	6	IEC: 17.5A, 250 V, T110 (230°F) 0.5-1.5mm <sup>2</sup> UL: 10A, 300V, 75°C (167°F) #26-#14 AWG, Cu	5mm	30mm
	PA001-8P	8	IEC: 17.5A, 250 V, T110 (230°F) 0.5-1.5mm <sup>2</sup> UL: 10A, 300V, 75°C (167°F) #26-#14 AWG, Cu	5mm	40mm
	PA001-10P	10	IEC: 17.5A, 250 V, T110 (230°F) 0.5-1.5mm <sup>2</sup> UL: 10A, 300V, 75°C (167°F) #26-#14 AWG, Cu	5mm	50mm

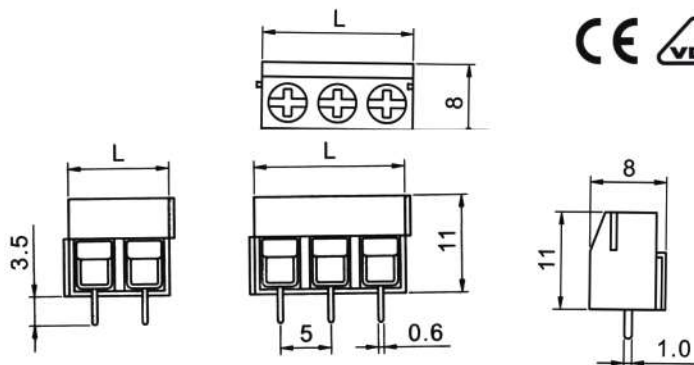

## 耐高溫閉端端子（150℃）

### High Temp Closed-End Wire Connectors(150℃)

PA 66工程塑料外殼，UL 94V-0 阻燃等級，耐高溫達150℃。

銅或鋁接線端子。

剝綫後插入端子內，用工具夾緊即可。

耐振動，不脫落。

可以取代傳統使用絕緣膠布的接綫方式。

適用於各種電器產品、燈飾及家庭配綫等接綫器材。

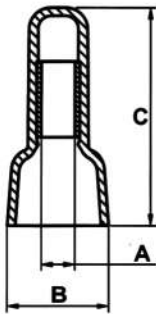

訂單編號 Cat. NO.	尺寸/Dimensions(mm)		
	A	B	C
CE2 150C	3.10	9.50	20.00
CE2X 150C	3.10	9.50	20.00
CE5 150C	4.10	12.50	25.50
CE5X 150C	4.40	12.50	25.50

訂單編號 Cat. NO.	顏色 Color	電氣規格與適用電綫 Ratings & Wire Range	包裝單位 Packing
Ce2 150C	白色 White	300 V Max. 150℃ (302°F) #22-#14 AWG, Cu	1, 000 Pcs/Bag 20, 000 Pcs/Ctn
CE2X 150C	白色 White	300 V Max. 150℃ (302°F) #22-#14 AWG, Cu	1, 000 Pcs/Bag 20, 000 Pcs/Ctn
CE5 150C	白色 White	300 V Max. 150℃ (302°F) #22-#14 AWG, Cu	1, 000 Pcs/Bag 10, 000 Pcs/Ctn
CE5X 150C	白色 White	300 V Max. 150℃ (302°F) #20-#14 AWG, Cu	1, 000 Pcs/Bag 10, 000 Pcs/Ctn



## 閉端端子

### Closed-End Wire Connectors

PA 66工程塑料外殼, UL 94V-2 阻燃等級。

銅或鋁接線端子。

剝線後插入端子內, 用工具夾緊即可。

耐振動, 不脫落。

可以取代傳統使用絕緣膠布的接線方式。

適用於各種電器產品、燈飾及家庭配線等接線器材。

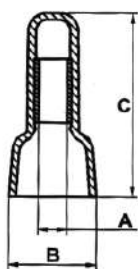

訂單編號 Cat. NO.	尺寸/Dimensions (mm)		
	A	B	C
CE1	2.60	7.80	18.00
CE1X	2.60	7.80	18.00
CE2	3.10	9.50	20.11
CE2I	3.30	9.50	20.00
CE2X	3.10	9.50	20.00
CE5I	4.40	12.50	25.50
CE5X	4.40	12.50	25.50
CE8	5.30	14.30	27.70

訂單編號 Cat. NO.	顏色 Color	電氣規格與適用電線 Ratings & Wire Range	包裝單位 Packing
CE1	原色 Nature	300 V Max. 105°C (221°F) #22-#18 AWG, Cu	1,000 Pcs/Bag
CE1X			30,000 Pcs/Ctn
CE2	原色 Nature	300 V Max. 105°C (221°F) #22-#14 AWG, Cu	1,000 Pcs/Bag
CE2I			20,000 Pcs/Ctn
CE2X			
CE5I	原色 Nature	300 V Max. 105°C (221°F) #22-#10 AWG, Cu	1,000 Pcs/Bag 10,000 Pcs/Ctn
CE5X	原色 Nature	300 V Max. 105°C (221°F) #20-#14 AWG, Cu	1,000 Pcs/Bag 10,000 Pcs/Ctn
CE8	原色 Nature	300 V Max. for UL 600 V Max. for CSA & CQC 105°C (221°F) #16-#10 AWG, Cu	5000 Pcs/Bag 6000 Pcs/Ctn

## 彈簧螺式接線頭

### Screw-On Wire Connectors

膠殼：熱可塑性工程塑料，UL94V-2阻燃等級，絕緣佳不易老化

彈簧：高級鋼材，堅韌牢靠

特點：共有五種型號，適用於包含22號到10號（AWG）電綫之各種綫徑組合

認證：通過UL列名，CSA及CQC認證

用途：適用於各種電器產品、家庭配綫等接綫器材，可重複使用，安全可靠

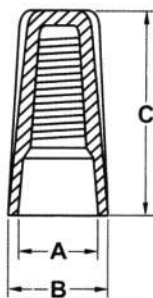

型號 ITEM NO	A (mm)	B (mm)	C (mm)
P1	6.70	8.60	15.20
P2	7.40	9.80	17.60
P3	9.90	12.70	22.00
P4	11.20	14.00	24.60
P6	13.30	16.40	26.50

型號 ITEM NO	顏色 Color	適用電綫 Wire Range	額定電氣規格 Electrical Ratings	安規認證 Approval			包裝單位 Packing
P1	橙色 Orange	#22-#14 AWG	电压：300 Volt Max. 温度：105°C (221°C)				1,000 Pcs/Bag 20,000 Pcs/Ctn
P2	橙色 Orange	#22-#14 AWG	电压：300 Volt Max. 温度：105°C (221°C)				1,000 Pcs/Bag 20,000 Pcs/Ctn
P3	橙色 Orange	#22-#14 AWG	电压：600 Volt Max. 温度：105°C (221°C)				500 Pcs/Bag 5000 Pcs/Ctn
P4	橙色 Orange	#22-#10 AWG	电压：600 Volt Max. 温度：105°C (221°C)				500 Pcs/Bag 5000 Pcs/Ctn
P6	红色 Red	#22-#10 AWG	电压：600 Volt Max. 温度：105°C (221°C)				500 Pcs/Bag 5000 Pcs/Ctn

## 彈簧螺式接線頭(H型)

### Screw-On Wire connectors(H Type)

膠殼：熱可塑性工程塑料，UL94V-0阻燃等級，絕緣佳不易老化

彈簧：高級鋼材，堅韌牢靠

特點：共有三種型號，適用於包含22號到10號（AWG）電綫之各種綫徑組合

認證：通過UL列名，CSA及CQC認證

用途：適用於各種電器產品、家庭配綫等接綫器材，可重複使用，安全可靠

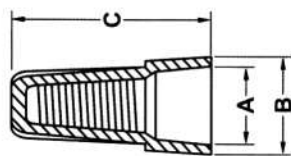

型號 ITEM NO	A (mm)	B (mm)	C (mm)
P3(H)	9.00	12.30	21.90
P4(H)	11.00	13.80	23.60
P6(H)	13.10	16.20	26.60

型號 ITEM NO	顏色 Color	適用電綫 Wire Range	額定電氣規格 Electrical Ratings	安規認證 Approval	包裝單位 Packing
P3(H)	淺橙色 Light Orange	#22-#14 AWG	电压：600 Volt Max. 温度：105°C (221°C)	UL SP CQC	500 Pcs/Bag 10,000 Pcs/Ctn
P4(H)	橙色 Orange	#22-#10 AWG	电压：600 Volt Max. 温度：105°C (221°C)	UL SP CQC	500 Pcs/Bag 5000 Pcs/Ctn
P6(H)	紅色 Red	#22-#10 AWG	电压：600 Volt Max. 温度：105°C (221°C)	UL SP CQC	500 Pcs/Bag 5000 Pcs/Ctn

## 耐高溫彈簧螺式接綫頭（150°C）

### HIGH TEMPERATURE CONNECTORS (150°C)

膠殼：PBT工程塑料，UL94V-0阻燃等級，絕緣佳不易老化

彈簧：高級鋼材，堅韌牢靠

特點：共有二種型號，適用於包含22號到10號（AWG）電綫之各種綫徑組合

認證：通過UL列名，CSA及CQC認證

用途：適用於各種電器產品、家庭配綫等接綫器材，可重複使用，安全可靠

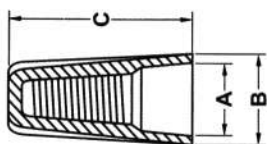

型號 ITEM NO	A (mm)	B (mm)	C (mm)
P1B	6.50	8.60	15.20
P3B	9.90	12.70	22.00

型號 ITEM NO	顏色 Color	適用電綫 Wire Range	額定電氣規格 Electrical Ratings	安規認證 Approval	包裝單位 Packing
P1B	黑色 Black	#22-#18 AWG	电压：300 Volt Max. 温度：150°C (302°F)	UL SP CQC	1,000 Pcs/Bag 20,000 Pcs/Ctn
P3B	黑色 Black	#22-#14 AWG	电压：300 Volt Max. 温度：150°C (302°F)	UL SP CQC	500 Pcs/Bag 10,000 Pcs/Ctn

## 電源綫扣

### Strain Relief Bushings

材質：尼龍66工程塑料，UL 94V-2阻燃等級，絕緣佳不易老化

顏色：黑色

認證：通過UL列名，CSA及CQC認證

用途：適用於各種電器產品及燈飾等電綫出口之固定與保護。

裝配方式：

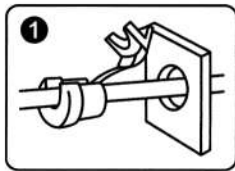

將電源綫放置綫扣內

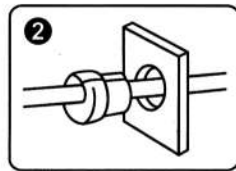

將綫扣結合夾緊

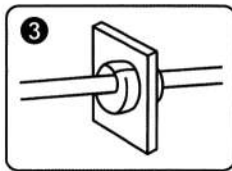

利用綫扣工具夾緊塞入機板出綫孔，即可固定電源綫

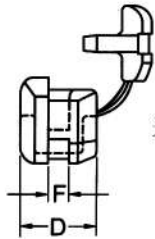

適用機板厚度

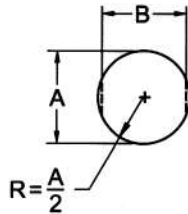

機板孔徑

綫扣工具  
Assembly tool



形狀 Cross Section Shape	型號 ITEM NO	適用UL電綫 UL Wires Accommodated	適用電綫尺寸 APPROX. WIRE SIZE (MM)		機板孔口徑 Mounting Hole		機板厚度 Max. Thickness F mm	綫扣長度 Length D mm	安規認證 Approval		包裝 Packing	
			A mm	B mm	A mm	B mm			UL	CSA	Pcs/Bag	Pcs/Ctn
扁綫用 Flat	2P-4	SPT-1	3x5.6		9.5	8.7	1.6	10.3	UL	CSA	10000	20000
	3P-4	SPT-1	3x5.6		11.0	9.9	1.6	10.3	UL	CSA	10000	10000
	3W-1	SPT-1	3x5.6		11.0	9.9	2.5	10.3	UL	CSA	10000	10000
	4N-4	SPT-52	3.71	3.8x7.6	12.7-13.1	11.8	1.6	10.3	UL	CSA	10000	10000
	4K-4	SPT-2	3.71	3.8x7.6	12.7-13.1	11.8	2.5	10.3	UL	CSA	10000	10000
圓綫用 Round	5N-4	SVI/SVT	6.4Φ-7.4Φ		12.7-13.1	11.5	1.6	11.0	UL	CSA	10000	10000
	5P-4	SVI/SVT	6.4Φ-7.4Φ		12.7-13.1	11.5	2.5	11.0	UL	CSA	1000	10000
	6N-4	SJT 3C#18	7.6Φ		15.9	14.0	1.6	14.8	UL	CSA	500	5000
	6P-4	SJT 3C#18	7.6Φ		15.9	14.0	3.2	14.8	UL	CSA	500	5000
	6N3-4	SJT 3C#16	8.2Φ-9.2Φ		15.9	14.0	1.6	14.8	UL	CSA	500	5000
	6P3-4	SJT 3C#16	8.2Φ-9.2Φ		15.9	14.0	3.2	14.8	UL	CSA	500	5000
	7N-2	SJT 3C#14	9.2Φ-10.5Φ 11.0Φ			16.8	1.6	19.0	UL	CSA	100	2000
	7P-2	SJT 3C#14	9.2Φ-10.5Φ 11.0Φ		15.9	15.9	3.2	19.0	UL	CSA	100	2000

## 扣式護綫套

### Snap Bushings

材質：尼龍66工程塑料，UL94V-2阻燃等級，絕緣佳不易老化

顏色：黑色

認證：通過UL列名，CSA認證

用途：一般電源綫出綫之固定均可使用，兼具絕緣與保護電源綫雙重

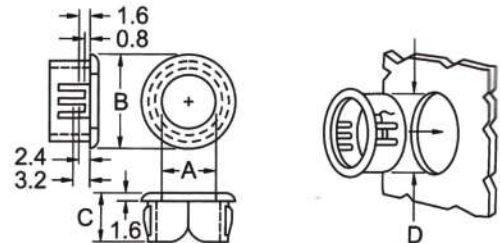

型號 ITEMNO	外徑/機板口徑 Mounting Hold Diameter Dmm	內徑 Inside Diameter A mm	覆蓋 Head Diameter B mm	高度 Over Height Cmm	安裝認證 APPROVAL		包裝單位 Packing	
					UL	CSA	Pcs/Bag	Pcs/Ctn
312-3	8.0	5.2	9.6	8.3			1000	30000
375-4	9.5	6.4	12.0	10.3			1000	20000
0811	11.1	8.2	13.6	10.3			1000	20000
0813	13.0	9.8	15.1	10.3			1000	10000
1216	15.6	12.9	18.1	10.3			1000	10000

## 開口型扣式護綫套

### Open/Closed Bushings

材質：尼龍66工程塑料，UL94V-2阻燃等級，絕緣佳不易老化

顏色：黑色

認證：通過UL列名，CSA認證

用途：電源供應器、控制箱或一般電源綫出綫之固定均可使用，兼具絕緣與保護電源綫雙重功能

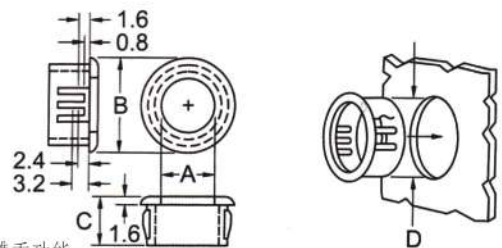

型號 ITEMNO	外徑/機板口徑 Mounting Hold Diameter Dmm	內徑 Inside Diameter A mm	覆蓋 Head Diameter B mm	高度 Over Height Cmm	包裝單位 Packing	
					Pcs/Bag	Pcs/Ctn
0813C	12.5-13.0	9.0	14.6	10.1	1000	10000
1216C	15.5-16.0	12.0	17.8	10.5	1000	10000
1419C	18.0-19.0	14.4	21.0	11.0	1000	8000

## 插式接線頭

### Push-In Wire Connectors

- PC工程塑料外殼, UL94V-0阻燃等級。
- 不銹鋼彈片、高導電性銅與銅板接端子。
- 剝線後直接插入線槽即可。
- 這合單股和多股導線槽規格的導線。
- 使用於燈飾配線和建築水電工程電氣接線盒內配線。

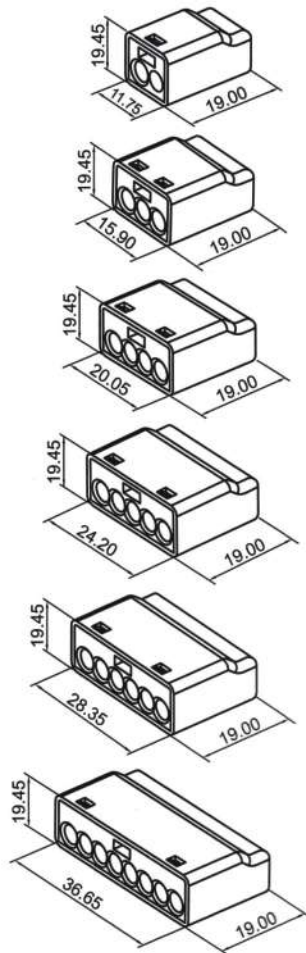

訂單編號 Order No.	顏色 Color	極數 Poles	電氣規格與適用電線 Ratings & Range	包裝單位 Packing
Pc352	黃色 Yellow	2	IEC:24A,450V,T110 0.5-2.5mm <sup>2</sup> ,單股/多股硬線 UL:600V,105°C(221°F) #22-#12 AWG,Sol/Str Cu	500Pcs/Bag 5,000Pcs/Ctn
Pc353	橙色 Orange	3	IEC:24A,450V,T110 0.5-2.5mm <sup>2</sup> ,單股/多股硬線 UL:600V,105°C(221°F) #22-#12 AWG,Sol/Str Cu	400Pcs/Bag 4,000Pcs/Ctn
Pc354	透明 Clear	4	IEC:24A,450V,T110 0.5-2.5mm <sup>2</sup> ,單股/多股硬線 UL:600V,105°C(221°F) #22-#12 AWG,Sol/Str Cu	300Pcs/Bag 3,000Pcs/Ctn
Pc355	藍色 Blue	5	IEC:24A,450V,T110 0.5-2.5mm <sup>2</sup> ,單股/多股硬線 UL:600V,105°C(221°F) #22-#12 AWG,Sol/Str Cu	300Pcs/Bag 3,000Pcs/Ctn
Pc356	紫色 Purple	6	IEC:24A,450V,T110 0.5-2.5mm <sup>2</sup> ,單股/多股硬線 UL:600V,105°C(221°F) #22-#12 AWG,Sol/Str Cu	250Pcs/Bag 2,500Pcs/Ctn
PC358	黑色 Black	8	IEC:24A,450V,T110 0.5-2.5mm <sup>2</sup> ,單股/多股硬線 UL:600V,105°C(221°F) #22-#12 AWG,Sol/Str Cu	200Pcs/Bag 2,000Pcs/Ctn

U1多股芯數:

#22Cu, Str AWG (少於或等於7芯)  
#20Cu, Str AWG (少於或等於10芯)  
#18Cu, Str AWG (少於或等於16芯)

#16Cu, Str AWG (少於或等於26芯)  
#14Cu, Str AWG (少於或等於19芯)  
#12Cu, Str AWG (少於或等於19芯)



## 插式接綫頭

### Push-In Wire Connectors

- PA 66和/或PC工程塑料外殼，UL94V-2阻燃等級。
- 不銹鋼彈片、高導電性銅與銅板接端子。
- 剝線後直接插入線槽即可。
- 適合單股和多股導線，可重復插入比先前拆掉更大規格的導線。
- 使用於燈飾配線和建築水電工程電氣接綫盒內配線。

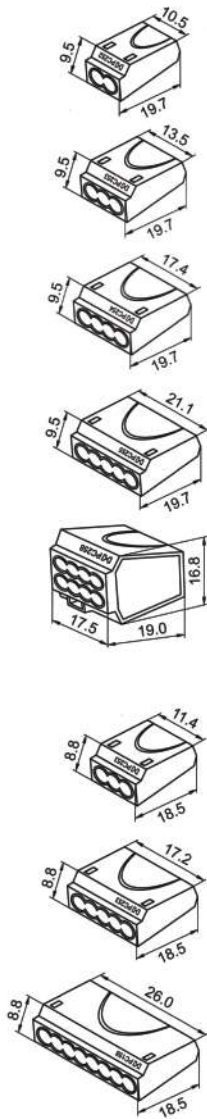

訂單編號 Order No.	顏色 Color	極數 Poles	電氣規格與適用電線 Ratings & Range	包裝單位 Packing
PC252	紅色 Red	2	IEC:24A,450V,T110 1-2.5mm <sup>2</sup> ,Sol UL:600V,105°C(221°F) #22-#12 AWG,Sol Cu	500Pcs/Bag 5,000Pcs/Ctn
PC252X				
PC253	橙色 Orange	3	IEC:24A,450V,T110 1-2.5mm <sup>2</sup> ,Sol UL:600V,105°C(221°F) #22-#12 AWG,Sol Cu	500Pcs/Bag 5,000Pcs/Ctn
PC253X				
PC254	黃色 Yellow	4	IEC:24A,450V,T110 1-2.5mm <sup>2</sup> ,Rigid UL:600V,105°C(221°F) #22-#12 AWG,Sol Cu	500Pcs/Bag 5,000Pcs/Ctn
PC254X				
PC255	灰色 Grey	5	IEC:24A,450V,T110 1-2.5mm <sup>2</sup> ,Sol UL:600V,105°C(221°F) #22-#12 AWG,Sol Cu	500Pcs/Bag 5,000Pcs/Ctn
PC255X				
PC258	黑色 Black	8	IEC:24A,450V,T110 1-2.5mm <sup>2</sup> ,Rigid UL:600V,105°C(221°F) #22-#12 AWG,Sol Cu	250Pcs/Bag 2,500Pcs/Ctn
PC153	灰色 Grey	3	IEC:17.5A,450V,T110 0.5-1.5mm <sup>2</sup> ,Rigid UL:600V,105°C(221°F) #20-#16 AWG,Sol Cu	500Pcs/Bag 5,000Pcs/Ctn
PC155	灰色 Grey	5	IEC:17.5A,450V,T110 0.5-1.5mm <sup>2</sup> ,Rigid UL:600V,105°C(221°F) #20-#16 AWG,Sol Cu	500Pcs/Bag 5,000Pcs/Ctn
PC158	灰色 Grey	8	IEC:17.5A,450V,T110 0.5-1.5mm <sup>2</sup> ,Rigid UL:600V,105°C(221°F) #20-#16 AWG,Sol Cu	250Pcs/Bag 2,500Pcs/Ctn

## 硅樹脂玻璃纖維套管(自熄管) Silicone Glassfiber Sleeving

是由無碱玻璃纖維紗編織成管後，塗以硅橡膠高溫處理而成。具有良好的介電性、自熄性和柔軟性，廣泛應用於H&N級汽車、造船、電機、家用電器、電熱設備、特種燈具、電視及電子儀器的內部線集束等絕緣保護。

Silicone Glassfiber Sleeving is braided into tubes with non-alkali glassfiber, and then painted with silicone through high temperature. It has such features as excellent electricity-avoidness, flame off-self and flesibility. It is widely used in insulating protection of H&N Grade automobile, shipbuiding, electrical machinery, home appliance, electric&heat equipment, special lightware and internal wires bunching of TV and electronic equipment, Etc.



技術指標: 自熄時間: 30秒  
Technology Index: Off-self time:30seconds

型號 ITEMNO	測試條件 Testing Condition	耐燃燒性 Lighting- resistance	耐溫 Temperature- resistance	擊穿電壓等級 Inserting Voltage	平均電壓 Average Voltage	最低個別值 The minmm Individual Value
SRC-15	U1 1441	UL VW-1	+200°C -10°C	C	1500V	1000V
SRC-25	U1 1441	UL VW-1	+200°C -10°C	B	2500V	1800V
SRC-70	U1 1441	UL VW-1	+200°C -10°C	A	7000V	5000V

### 內徑尺寸: Inside diameter measurement

內徑尺寸: Inside diameter measurement		最小壁厚 The mininum wall thickness	
標稱 Range	公差 Tolerance	A級A grade	B.C.級別B.C. grade
0.5-2.5mm	+0.25-0.00mm	0.38mm	0.20mm
3.0-4.5mm	+0.30-0.00mm	0.45mm	0.23mm
5.0-6.0mm	+0.40-0.00mm	0.45mm	0.28mm
7.0-9.0mm	+0.55-0.00mm	0.50mm	0.32mm
10.0-14.0mm	+0.75-0.00mm	0.60mm	0.40mm
15.0-25.0mm	+0.85-0.00mm	0.64mm	0.43mm

## 硅橡胶玻璃纤维(内纤外胶)套管 Silicone Rubber Glassfiber insulating Sleeving

硅橡胶玻璃纤维(内纤外胶)套管：是由無碱玻璃纖維紗編織成管後，塗以硅橡膠高溫處理而成。具有比硅樹脂玻璃纖維套管更加良好的介電性、自熄性和柔軟性，廣泛應用於H&N級汽車、造船、電機、家用電器、電熱設備、特種燈具等絕緣保護。

Silicone Rubber Glassfiber insulating Sleeving(inside fiber and outside fiber)is braided into tubes with non-alkali glassfiber,and then painted with silicone rubber through high temperature.It has better features than silicone glassfiber tubes in the aspect of electricity-avoidness,flame off-self and flexibility.It is widely used in insulating protection of H&N Grade automobile,shipbuiding,electrical machinery,home appliance,electric&heat equipment,special lightware.Etc.

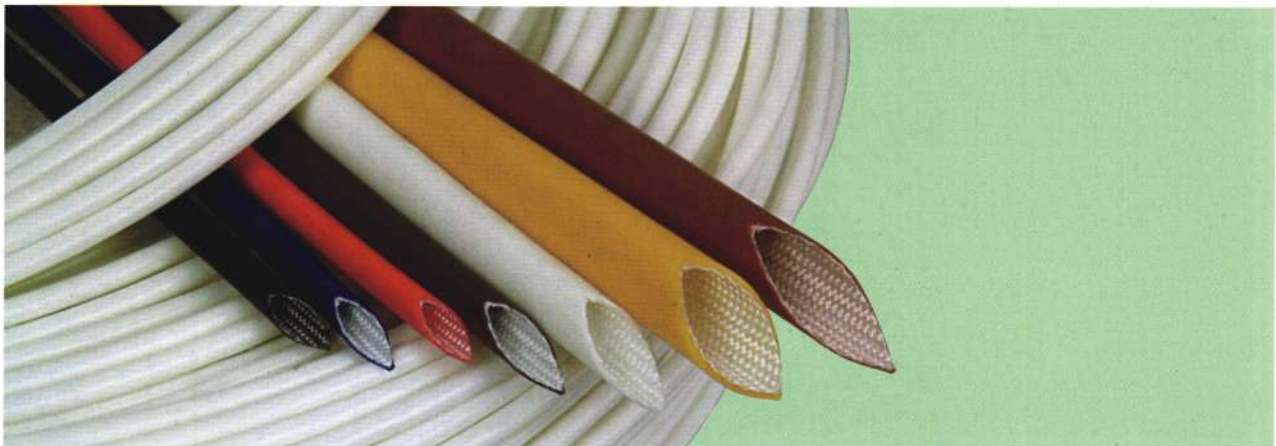

### 內徑尺寸: Inside diameter measurement

內徑尺寸: Inside diameter measurement		壁厚 Wall thickness	
標稱 Range	公差 Tolerance	4000V	7000V
0.5-2.0mm	+0.20-0.00mm	0.40±0.05mm	0.45±0.05mm
2.5-3.0mm	+0.25-0.00mm	0.40±0.05mm	0.50±0.05mm
3.5-5.0mm	+0.35-0.00mm	0.45±0.05mm	0.55±0.05mm
6.0-9.0mm	+0.50-0.00mm	0.50±0.05mm	0.60±0.05mm
10.0-12.0mm	+0.70-0.00mm	0.60±0.05mm	0.65±0.05mm
13.0-25.0mm	+0.80-0.00mm	0.65±0.05mm	0.70±0.05mm

### 技術指標:

Technology Index:

自熄時間: 30秒

Off-self time:30seconds

型號 ITEM NO	測試條件 Testing Condition	耐燃燒性 Lighting- resistance	耐溫 Temperature- resistance	平均電壓 Average Voltage	最低個別值 The minmum Individual Value
SRC-40	UL1441	UL VW-1	+200°C -10°C	4000V	3000V
SRC-70	UL1441	UL VW-1	+200°C -10°C	7000V	5000V

### 性能參數 Specification

項目 ITEM		性能指標 VALUE	
連續使用溫度範圍	Continuous Operating Temperature	-10°C +200°C	
耐溫性	Temperature Endurance	265°C ±2°C 168≥1/2原電壓值	Original value of voltage
熱老化	Aging Test	260°C, 6小時、無裂紋	6 hrs without crackle
冷彎曲	Cold Bend	無裂紋	without crackle
水平燃燒	Horizontal Flame test	<30秒	<30seconds
燃燒(VW-1)	Flame Retardance	<30秒	<30seconds
水解穩定性	Submerge Water Test	不發粘、不變形、不軟化	Non-sticky, non-deformed, non-bated

## 硅橡膠玻璃纖維(內膠外纖)套管

### Silicone Rubber Glassfiber insulating Sleeving

是由硅橡膠擠出成管後，外加于編織玻璃纖維再塗以硅樹脂高溫處理而成，具有極好的絕緣耐溫保護作用，同樣廣泛應用于H&N級汽車、造船、電機、家用電器，電熱設備、特種燈具內部等絕緣保護。

Silicone Rubber Glassfiber insulating Sleeving(inside rubber and outside fiber)is extruded into tubes from silicone rubber, coated with braided glassfiber and then painted with silicone through high temperature. It has excellent insulating protection and temperature-resistance function. It is also widely used in insulating protection of H&N Grade automobile, shipbuiding, electrical machinery, home appliance, electric&heat equipment, special lightware. Etc.

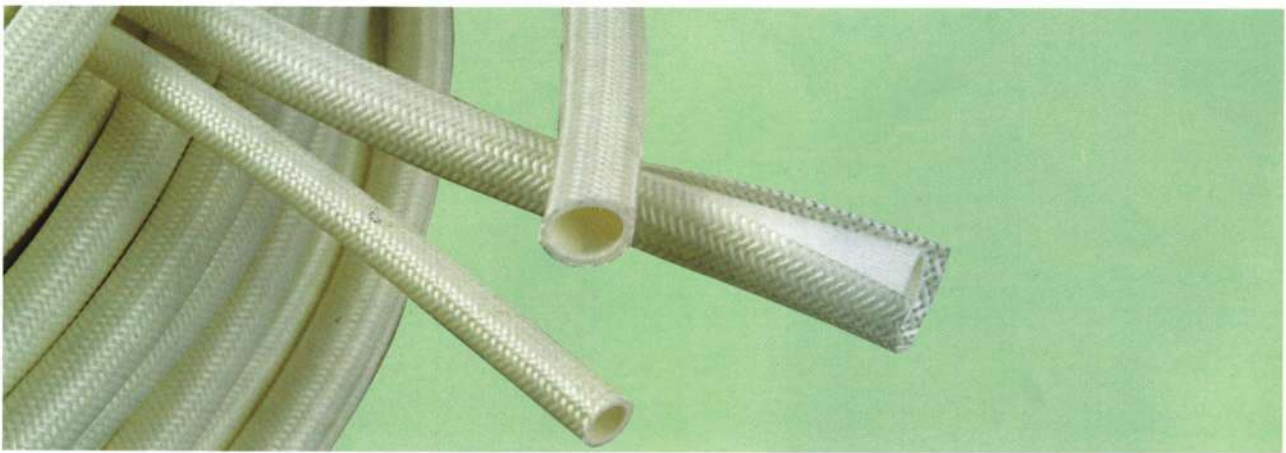

#### 內徑尺寸: Inside diameter measurement

內徑尺寸: Inside diameter measurement		壁厚 Wall thickness
標稱 Range	公差 Tolerance	
1.0-2.5mm	+0.20-0.00mm	0.60±0.05mm
3.0-5.0mm	+0.30-0.00mm	0.70±0.05mm
6.0-7.0mm	+0.35-0.00mm	0.75±0.05mm
8.0-9.0mm	+0.40-0.00mm	0.80±0.05mm
10.0-12.0mm	+0.50-0.00mm	0.90±0.05mm
13.0-25.0mm	+0.60-0.00mm	1.30±0.05mm

#### 技術指標:

Technology Index:

自熄時間: 30秒

Off-self time:30seconds

型號 ITEM NO	測試條件 Testing Condition	耐燃燒性 Lighting- resistance	耐溫 Temperature- resistance	平均電壓 Average Voltage	最低個別值 The minnum Individual Value
SRC-70	U11441	UL VW-1	+200℃ -10℃	7000V	6000V

#### 性能參數 Specification

項目 ITEM		性能指標 VALUE	
連續使用溫度範圍	Continuous Operating Temperature	-10℃ +200℃	
耐溫性	Temperature Endurance	265℃ ± 2℃ 168≥1/2原電壓值	Orginal value of voltage
熱老化	Aging Test	260℃、6小時、無裂紋	6 hrs without crackle
冷彎曲	Cold Bend	無裂紋	without crackle
水平燃燒	Horizontal Flame test	<30秒	<30seconds
燃燒(VW-1)	Flame Retardance	<30秒	<30seconds
水解穩定性	Submerge Water Test	不發粘、不變形、不軟化	Non-sticky, non-deformed, non-bated

## 純硅橡膠軟管PSR系列

### Pure Silicone Rubber Flexible Tube PSR

PSR系列主要採用日本、美國、德國原材料，廣泛適用電器、燈飾、醫療器械等，可根據客戶的要求生產高透明、半透明、乳白色及阻燃、內徑大、小、管壁薄、厚的PSR系列產品。

Pure Silicone Rubber Flexible Tube PSR Series, PSR series mainly adopt raw materials from Japan, USA and Germany. Widely used in electrical equipment, illumination, medical equipment etc. PSR series can provide various tubes according to customers request such as highly-transparent, half-transparent, milky white or other colors, flame-resistance, big or small size of ID and thick or thin wall tubes of PSR series.



型號 ITED NO	型號描述 Item Description		耐壓 Voltage-resistance	耐溫 Temperature-resistance	硬度 Hardness	拉斷伸長 Extention
PRS-T	半透明 (單壁厚0.5-0.7mm)	Half-Transparent (Single wall thickness 0.5-0.7mm)	4000V-10000V	-60°C+200°C	60°C-80°C	(%)≥250
PRS-Ta	半透明加厚	Half-Transparent(wall thickness)	4000V-10000V	-60°C+200°C	60°C-80°C	(%)≥250
PRS-HT	高透明 (單壁厚0.5-0.7mm)	Half-Transparent (Single wall thickness 0.5-0.7mm)	4000V-10000V	-60°C+200°C	60°C-80°C	(%)≥250
PRS-HTa	高透明加厚	Half-Transparent(wall thickness)	4000V-10000V	-60°C+200°C	60°C-80°C	(%)≥250
PRS-M	乳白色 (單壁厚0.5-0.7mm)	Milky Whithe (Single wall thickness 0.5-0.7mm)	4000V-10000V	-60°C+200°C	60°C-80°C	(%)≥250
PRS-Ma	乳白色加厚型	Milky Whithe(Wall thickening)	4000V-10000V	-60°C+200°C	60°C-80°C	(%)≥250
PRS-MS	乳白色阻燃型	Milky Whithe(Flame-resistance)	4000V-10000V	-60°C+200°C	60°C-80°C	(%)≥250
PRS-MSa	乳白色阻燃+加厚型	Milky Whithe Flame-resistance and Wall thickening	4000V-10000V	-60°C+200°C	60°C-80°C	(%)≥250

## 耐高温特殊玻璃纖維套管(TGS-1W-600C)

### High Temperature-Resistance Special Glassfiber Sleeving

TGS-1W-600C是一種新型特殊耐高温玻璃纖維套管，主要用于汽車、造船、電熱器件、電子束綫、燈飾、電機設備等。

TGS-1W-600C is a new kind of special high temperature-resistance glassfiber sleeving which is mainly use in automobile, shipbuiding electrical equipment, illumination, motor equipment etc.

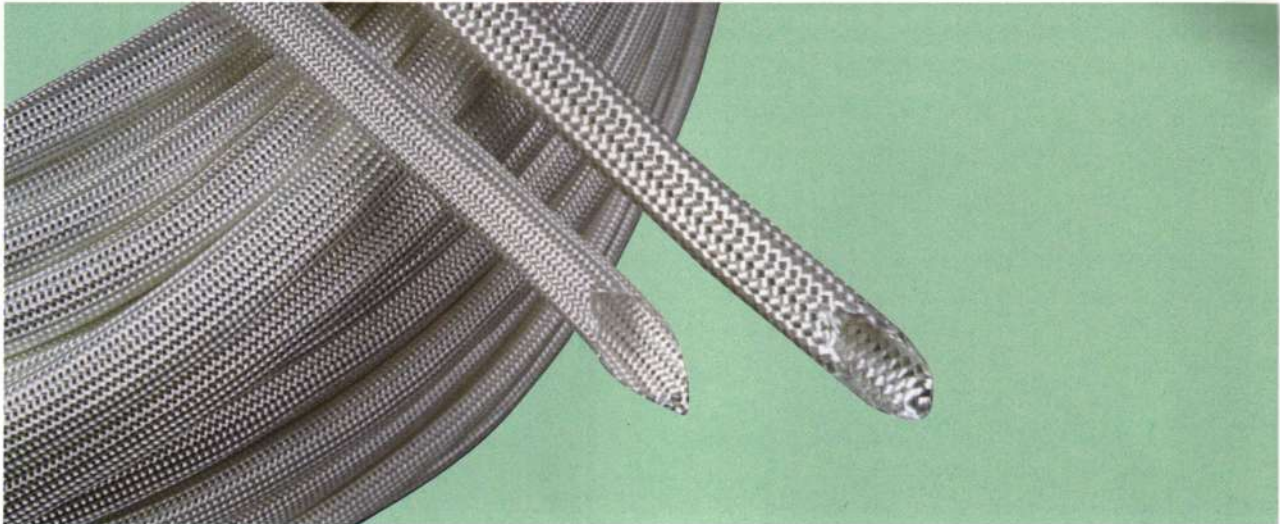

型號 ITEN NO	壁厚 Wall thickness	耐溫 Temperature-resistance	耐壓 Voltage-resistance	阻燃性 Flame resistance
0.5mm-3.0mm	0.20±0.05mm	-60℃+600℃	300-700V	VW-1
4.0mm-6.0mm	0.30±0.05mm	-60℃+600℃	300-700V	VW-1
7.0mm-12.0mm	0.35±0.05mm	-60℃+600℃	300-700V	VW-1
14.0mm-30.0mm	0.43±0.05mm	-60℃+600℃	300-700V	VW-1

## 黃臘管

### PVC Fiberglass Sleeving

黃臘管是以無碱玻璃纖維編織而成，并塗以聚氯乙烯樹脂經塑化而成的電氣絕緣漆管。

本產品具有良好的柔軟性、彈性、絕緣性和耐化學性，適用於電機、電器、變壓器、儀器、儀表、醫療設備、無線電、電視機以及電風扇、洗衣機等家用電器裝置的布綫絕緣和機械保護。

Polyvinyl chloride glass tube is elecdrtric insulated tube weaved by alkali-free fiberglass and coated with PVC material. The products with good plasticity, flexibility, insulation and chemical-resistance are applied to layout insulation and mechanical protection for motors, electrical equipments, transformers, instruments, meters, modical instruments, wireless devices, TVsets, fans, washing machines and some other household appliances.

主要特性 Specification:

1. 耐溫指數: 105℃
  2. 擊穿電壓: 室溫下1500-2500V
  3. 產品規格: Φ0.5mm~Φ27mm
  4. 成品長主: 1000mm(其它長度可按客户要求加工)
1. Heat-resistance index:105℃
  2. Breakdown voltage:1500-2500V in room temperature
  3. Dimension:Φ0.5mm~Φ27mm
  4. Length:1000mm(specific production as customer required)



## PET編織網管

### PET tube

PET編織網管由高強度的環保PET單絲編織而成,耐磨隔熱,耐老化抗紫外綫光,耐酸、碱、鹽溶液,溫度範圍內40°C~150°C,具有較好的伸縮性,彈性、耐磨性、阻燃性以及耐溫等到特性,外觀平整光亮、色彩多樣、規格齊全,廣泛用于各類汽車配綫、電腦內接綫、電纜及音箱綫的束緊及保護。

PET tube is braided into tubes with high tensile environment-protected PET monofilament, it has excellence outstanding in endurance, aging and ultraviolet protecting and high resistance to acidic and alkali and saline solutions, it can be used in temperature from -40°C to +150°C, it has excellent retractility, flexibility, abrasion-resistance, flame-resistance and temperature-resistance etc, It has good appearance and various colors. It is widely used in bundling protection of automobile of automobile wire, computer wire, cable wire and sound box wire etc.



#### 使用說明(Instructions):

本產品使用造型需依照四組織參數(A、B、C、D)決定,說明如下:

The type of the products should be selected to 4 set of parametes(A、B、C、D):

$\frac{1}{A}$	$\frac{25}{B}$	$\frac{048}{C}$	$\frac{006}{D}$	$\frac{3}{A}$	$\frac{20}{B}$	$\frac{072}{C}$	$\frac{018}{D}$
---------------	----------------	-----------------	-----------------	---------------	----------------	-----------------	-----------------

A-表示每股中絲的根數 Fiber number of each tube

B-表示單絲的直徑 Diameter of single fiber

C-表示編織的股數 Number of skeins

D-表示管的平壓寬度 Flat width of tube

PET網管規格表 PET tube specification table

序號 No.	型號 ITEM NO	外徑 OD(mm)	序號 No.	型號 Model	外徑 OD(mm)
24#	120024	3-6	56#	120056	8-16
	125024	3-6		125056	8-16
	320024	4-8		320056	10-20
	325024	4-8		325056	10-20
32#	120032	4-8	64#	120064	9-18
	125032	4-8		125064	9-18
	320032	5-10		320064	12-24
	325032	5-10		325064	12-24
36#	120036	5-10	72#	120072	10-12
	125036	5-10		125072	10-12
	320036	6-12		320072	15-30
	325036	6-12		325072	15-30
40#	120040	6-12	96#	120096	12-24
	125040	6-12		125096	12-24
	320040	7-14		320096	20-40
	325040	7-14		325096	25-50
48#	120048	7-14	120#	120120	15-30
	125048	7-14		125120	15-30
	320048	8-16		320120	30-70
	325048	8-16		325120	35-100

## 聚丙烯酸酯玻璃纖維套管

### Acrylic Resin Glassfiber Slewing

#### 材質、特性和用途

聚丙烯酸酯玻璃纖維套管主要採用優質原材料，內層為玻璃纖維編織，再塗以丙烯酸酯高溫處理而成，廣泛適用於F級電機、家用電器、電熱設備、特種燈具等絕緣保護。

#### Material & Feature & Application

Silicone Rubber Glassfiber Insulating Slewing (inside rubber and outside fiber) is extruded into tubes from silicone rubber, coated with braided glassfiber and then painted with silicone through high temperature. It has excellent insulating protection and temperature-resistance function. It is also widely used in insulating protection of H&N Grade automobile, shipbuilding, electrical machinery, home appliance, electric & heat equipment, special lightware. Etc.

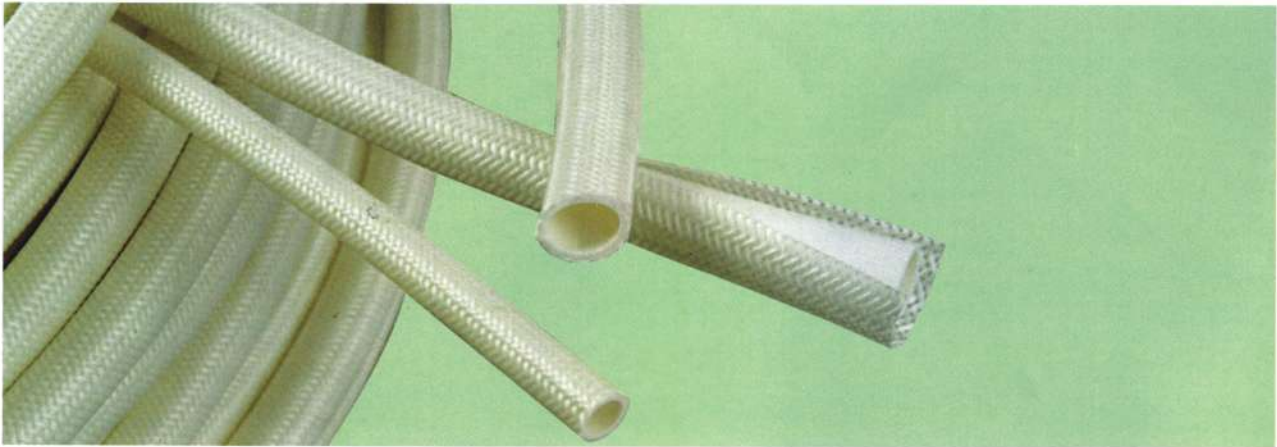

#### 內徑尺寸: Inside diameter measurement

內徑尺寸: Inside diameter measurement		壁厚 Wall thickness
標稱 Range	公差 Tolerance	
1.0-2.5mm	+0.20-0.00mm	0.60±0.05mm
3.0-5.0mm	+0.30-0.00mm	0.70±0.05mm
6.0-7.0mm	+0.35-0.00mm	0.75±0.05mm
8.0-9.0mm	+0.40-0.00mm	0.80±0.05mm
10.0-12.0mm	+0.50-0.00mm	0.90±0.05mm
13.0-25.0mm	+0.60-0.00mm	1.30±0.05mm

#### 技術指標:

Technology Index:

自熄時間: 30秒

Off-self time: 30seconds

型號 ITEN NO	測試條件 Testing Condition	耐燃燒性 Lighting- resistance	耐溫 Temperature- resistance	平均電壓 Average Voltage	最低個別值 The minimum Individual Value
SRC-70	UL 1441	UL VW-1	+200°C -10°C	7000V	6000V

#### 性能參數 Specification

項目 ITEM	性能指標 VALUE
連續使用溫度範圍 Continuous Operating Temperature	-10°C +200°C
耐溫性 Temperature Endurance	265°C ±2 °C 168≥1/2原電壓值 Original value of voltage
熱老化 Aging Test	260°C、6小時、無裂紋 6 hrs without crackle
冷彎曲 Cold Bend	無裂紋 without crackle
水平燃燒 Horizontal Flame test	<30秒 <30seconds
燃燒(VW-1) Flame Retardance	<30秒 <30seconds
水解穩定性 Submerge Water Test	不發粘、不變形、不軟化 Non-sticky, non-deformed, non-bated

## 熱收縮套管

### Heat Shrinkable Tube

#### 材質、特性和用途

熱縮套管是採用優質高聚物，經科學配方、機械共混成高聚物合金，產品成型後經電子加速器輻照交聯、連續擴張而成。該產品具有柔軟、阻燃、收縮快、性能穩定等優點。

廣泛應用於電線連接、焊點保護、電線端部、纜束、電子器件防護和絕緣處理。

#### Material & Feature & Application

Heat Shrinkable Tube forms by chemical cross-linked (by radiation) thermally stabilized flame retarded polyolefin. It has excellent un-flammability, flexibility, and insulation. The shrinking temperature is very low and it can shrink very quickly.

It is widely used for various electric insulation and bonding of cables and connectors and applied for connecting end handling of electric wire, insulating and harness of electric wire.



#### 性能指標

測試項目 Property	指標 Value
起始溫度(Shrink temperature)	90°C
適用溫度(Temperature Range)	-55°C-125°C
徑向收縮率(Radial Shrinking Ratio)	≥50%
軸向收縮率(Longitudinal shrinking ratio)	≤5%
擴張強度(Tensile Strength)	≥14Mpa
老化(Aging)	158.0±1.0°C放置7天 7 Days Air Cren at 158.0±1.0°C 134.0±1.0°C放置60天 60 Days Air Cren at 134.0±1.0°C
老化後的擴張強度(Tensile Strength after Aging)	≥100Mpa
老化後的斷裂伸長率(Elongation after aging)	≥200%
體積電阻率(Volume Resistivity)	≥10Ω·cm
擊穿強度(Dielectric strength)	≥25KV/mm
阻燃性(Flammability)	VW-1

產品規格	收縮前(mm)		收縮後(mm)		標準包裝米/盤
	最小內徑	壁厚	最大內徑	壁厚	
Φ0.8	1.00 ± 0.30	0.18	0.40	0.33	200
Φ1.0	1.50 ± 0.30	0.18	0.50	0.33	200
Φ1.5	2.0 ± 0.30	0.25	0.75	0.36	200
Φ2.0	2.50 ± 0.30	0.25	1.00	0.43	200
Φ2.5	3.00 ± 0.30	0.25	1.25	0.43	200
Φ3.0	3.50 ± 0.30	0.25	1.50	0.43	200
Φ3.5	4.00 ± 0.30	0.25	1.75	0.43	200
Φ4.0	4.50 ± 0.30	0.25	2.00	0.43	200
Φ5.0	5.50 ± 0.30	0.25	2.50	0.43	100
Φ6.0	6.50 ± 0.30	0.25	3.00	0.56	100
Φ7.0	7.50 ± 0.30	0.30	3.50	0.56	100
Φ8.0	8.50 ± 0.30	0.30	4.00	0.56	100
Φ9.0	9.50 ± 0.30	0.30	4.50	0.56	100
Φ10.0	10.50 ± 0.50	0.30	5.00	0.56	100
Φ11.0	11.50 ± 0.50	0.30	5.50	0.56	100
Φ12.0	12.50 ± 0.50	0.30	6.00	0.56	100
Φ13.0	13.50 ± 0.50	0.35	6.50	0.69	100
Φ14.0	14.50 ± 0.50	0.35	7.00	0.69	100
Φ15.0	15.50 ± 0.60	0.35	7.50	0.69	100
Φ16.0	16.50 ± 0.60	0.35	8.00	0.69	100
Φ18.0	19.00 ± 0.60	0.40	9.00	0.76	100
Φ20.0	21.00 ± 0.60	0.40	10.00	0.76	100
Φ22.0	23.00 ± 0.70	0.45	11.00	0.89	100
Φ25.0	26.00 ± 0.70	0.45	12.50	0.89	50
Φ28.0	29.50 ± 0.70	0.45	14.00	0.89	50
Φ30.0	31.50 ± 0.70	0.45	15.00	0.89	50
Φ35.0	36.00 ± 0.70	0.50	17.50	0.89	50
Φ40.0	40.70 ± 0.70	0.50	20.00	0.89	50
Φ50.0	50.70 ± 0.70	0.50	25.00	1.00	50

## PVC套管

### PVC Tube



#### 物理特性:

工作溫度(Working Temperature): $-20^{\circ}\text{C}+105^{\circ}\text{C}$

電介質強度(Dielectric Strdngrth):2500Voits/Minute

最低壁厚(Min. Wall.Thicking):SHT-300/0.35mm SHT-600/0.56mm

燃燒性(Flmablity):符合(ULVW-1.CSA.OFT)測試

內徑允許誤差(Insid Diameter): $\pm 0.10\text{mm}$

抗張強度(Tensile strength):200kg/cm

伸張度(Elogation at break):180%

顏色(Standard colours):

一般用于電器、綫束、變壓器馬達引綫等絕緣和保護

For general insolation and protection for appliance, Wire barness,transformer,lead wurd of moter,etc.

綫規 AWG	內徑(毫米) Inside Dlameter(mm)	厚壁(毫米)600V105°C Wall Thickness(mm)	厚壁(毫米)300V105°C Wall Thickness(mm)
AWGNO.24	0.56 ± 0.10	0.50 ± 0.06	0.32 ± 0.06
AWGNO.23	0.66 ± 0.10	0.50 ± 0.06	0.32 ± 0.06
AWGNO.22	0.71 ± 0.10	0.50 ± 0.06	0.40 ± 0.06
AWGNO.21	0.81 ± 0.10	0.50 ± 0.06	0.40 ± 0.06
AWGNO.20	0.86 ± 0.10	0.50 ± 0.06	0.40 ± 0.06
AWGNO.19	0.96 ± 0.10	0.50 ± 0.06	0.40 ± 0.06
AWGNO.18	1.07 ± 0.15	0.65 ± 0.08	0.40 ± 0.06
AWGNO.17	1.19 ± 0.15	0.65 ± 0.08	0.40 ± 0.06
AWGNO.16	1.34 ± 0.15	0.65 ± 0.08	0.40 ± 0.06
AWGNO.15	1.50 ± 0.15	0.65 ± 0.08	0.40 ± 0.06
AWGNO.14	1.68 ± 0.15	0.65 ± 0.08	0.40 ± 0.06
AWGNO.13	1.93 ± 0.20	0.65 ± 0.08	0.40 ± 0.06
AWGNO.12	2.16 ± 0.20	0.65 ± 0.08	0.40 ± 0.06
AWGNO.11	2.41 ± 0.20	0.65 ± 0.08	0.40 ± 0.06
AWGNO.10	2.69 ± 0.20	0.65 ± 0.08	0.40 ± 0.06
AWGNO.9	3.00 ± 0.25	0.65 ± 0.08	0.52 ± 0.08
AWGNO.8	3.38 ± 0.25	0.65 ± 0.08	0.52 ± 0.08
AWGNO.7	3.76 ± 0.25	0.65 ± 0.08	0.52 ± 0.08
AWGNO.6	4.22 ± 0.30	0.65 ± 0.08	0.52 ± 0.08
AWGNO.5	4.72 ± 0.30	0.65 ± 0.08	0.52 ± 0.08
AWGNO.4	5.28 ± 0.30	0.65 ± 0.08	0.52 ± 0.08
AWGNO.3	5.94 ± 0.30	0.65 ± 0.08	0.52 ± 0.08
AWGNO.2	6.68 ± 0.30	0.65 ± 0.08	0.52 ± 0.08
AWGNO.1	7.46 ± 0.30	0.65 ± 0.08	0.52 ± 0.08
AWGNO.0	8.38 ± 0.30	0.65 ± 0.08	0.52 ± 0.08

## 鐵弗龍套管

PTFE Tube

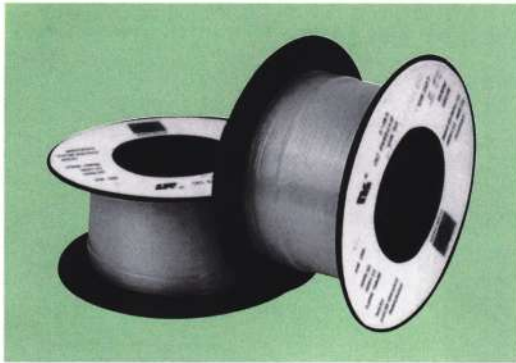

### 材質、特性和用途

鐵弗龍套管是用進口優質聚四氟乙烯樹脂擠壓燒結而成。該產品具有耐高溫(280℃~300℃)、耐腐蝕、耐磨等特點。

廣泛應用於機械化、電子電器、汽車、航天、化工、通訊等各種領域。

### Material & Feature & Application

PTFE Tube is made of PTFE. It has high temperature resistance, corrosion resistance and excellence insulation.

This tube is widely used in industries of electrical, computer, chemical, high temperature areas, aerospace, military and transmission system etc.

鐵弗龍絕緣套管尺寸表

規格	內徑ID (mm)			外徑OD (mm)		
	最小	正常	最大	S型	T型	L型
AWG 30	0.25	0.30	0.38	0.76	0.76	0.60
28	0.33	0.38	0.46	0.84	0.84	0.68
26	0.41	0.46	0.53	0.92	0.92	0.76
24	0.51	0.56	0.66	1.16	1.06	0.86
23	0.58	0.66	0.74	1.26	1.16	0.96
22	0.66	0.71	0.81	1.31	1.21	1.01
21	0.74	0.81	0.89	1.41	1.31	1.11
20	0.81	0.86	0.97	1.66	1.46	1.16
19	0.91	0.96	1.07	1.76	1.56	1.26
18	1.01	1.07	1.17	1.87	1.67	1.37
17	1.14	1.19	1.32	1.99	1.79	1.49
16	1.29	1.34	1.47	2.14	1.94	1.64
15	1.45	1.50	1.65	2.30	2.10	1.80
14	1.62	1.68	1.83	2.48	2.28	2.08
13	1.83	1.93	2.05	2.73	2.53	2.33
12	2.05	2.16	2.31	2.96	2.77	2.56
11	2.31	2.41	2.57	3.21	3.01	2.81
10	2.59	2.69	2.84	3.49	3.29	3.09
9	2.90	3.00	3.15	4.00	3.76	3.40
8	3.28	3.38	3.53	4.38	4.14	3.78
7	3.65	3.76	3.94	4.76	4.52	4.16
6	4.11	4.22	4.41	5.22	4.98	4.72
5	4.62	4.72	4.95	5.73	5.48	5.22
4	5.18	5.28	5.53	6.28	6.04	5.78
3	5.81	5.94	6.20	6.94	6.70	6.44
2	6.55	6.68	6.93	7.68	7.44	7.18
1	7.34	7.46	7.75	8.46	8.22	7.96
0	8.26	8.38	8.69	9.38	9.14	8.88

# HEAVY POWER (廣東代理)

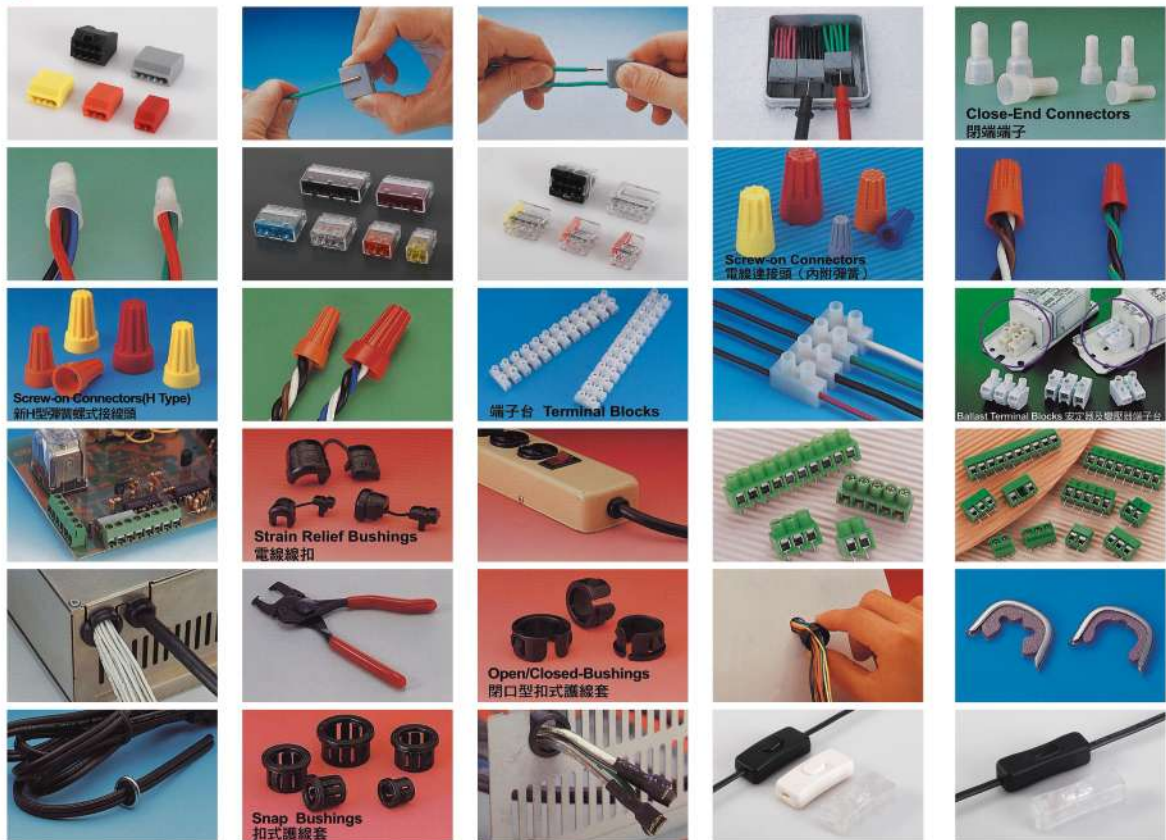

# Teilbar OPENWISE (廣東代理)

